



2024 | ÜRÜN ve FİYAT KATALOĞU

PRODUCT and PRICE CATALOGUE

RICO[®]

PROFESSIONAL

Profesyonel Çözüm Ortağınız



- LOKMA GRUBU • CIRCIR KOLLARI • ANAHTAR GRUPLARI • TORNAVİDA VE MAKET BIÇAKLARI • PENSE GRUPLARI • ALLEN GRUPLARI • OTOMOTİV BİTS UÇLARI
- BORU ANAHTARLARI • OTOMOTİV GRUBU • HAVALI ALETLER GRUBU • MATKAP UÇLARI • KESKİ, EĞE, ÇEKİÇ GRUBU • BAHÇE GRUBU • GENEL ÇEŞİTLER

RICO[®]
PROFESSIONAL

profesyonellerin
tercihi



www.rico.com.tr

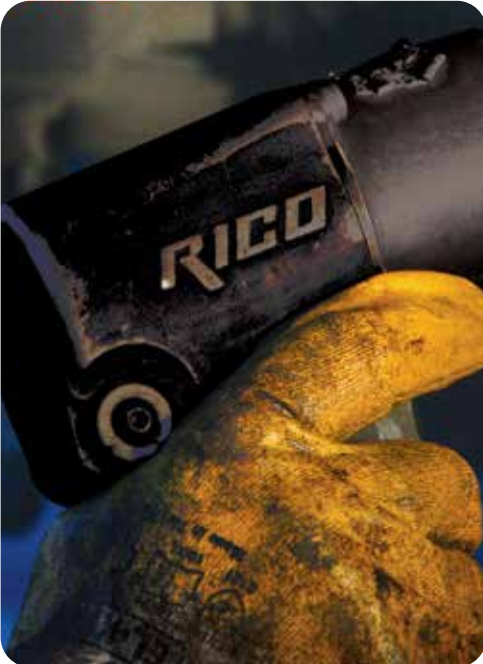



Değerli İş Ortaklarımız;

Ticaretin esası olan, "yüksek kalite ve uygun fiyat" kuralını RİCO olarak var olduğumuz günden beri hep göz önünde bulundurduk ve bu ideali gerçekleştirirken, sizlerin de bildiği gibi, ürünlerimizin ve hizmetimizin kalitesinden asla taviz vermedik.

Teknolojinin son hızla ilerlediği günümüzde, değişimin vazgeçilmez ve karşı konulmaz temel bir değer yargısı ve gerçeği olduğunu biliyoruz. Ancak sadece değişime adapte olmayı değil, değişimin öncüsü olmayı da istiyoruz. Bu nedenle gerek üretim ve gerekse yönetim teknolojilerimizi bu amaç etrafında odaklıyoruz. Amacımız müşterilerimizin memnuniyetini her geçen gün daha da arttırmak... Daha kaliteli ürünler, Daha etkin bir servis, Daha yaygın bir ürün yelpazesi...

Bu hedeflerimizi gerçekleştirmek için hızla ilerliyoruz. Müşterilerimizin bize verdikleri sonsuz destek için teşekkür ediyoruz. Her zaman daha iyide, daha güzelde buluşmak dileğiyle.

Saygılarımızla;
KARAKUŞ HIRDAVAT İMALAT SAN. VE TİC. LTD. ŞTİ.
YÖNETİM KURULU



İÇİNDEKİLER / INDEX

5-29	LOKMA GRUBU
30-32	CIRCIR KOLLARI
33-37	ANAHTAR GRUPLARI
38-47	PENSE GRUPLARI
48-58	TORNAVIDA GRUBU
59-63	ALLEN GRUPLARI
64-72	OTOMOTİV BITS UÇLAR
73-75	BORU ANAHTARLARI
76-80	KRIKO GRUBU
81-102	OTOMOTİV GRUBU
103-109	HAVALI ALETLER GRUBU
110-112	MATKAP UÇLARI
113-123	KESKİ, EĞE, ÇEKİÇ, KAPORTACI ÇEKİÇLERİ, TRANÇA ÇEKİÇLERİ, DAYAMALAR
124-131	BAHÇE GRUBU
132-140	GENEL ÇEŞİTLER

**PROFESYONEL
ÇÖZÜM ORTAĞINIZ**

RICO[®]
PROFESSIONAL

LOKMA GRUPLARI

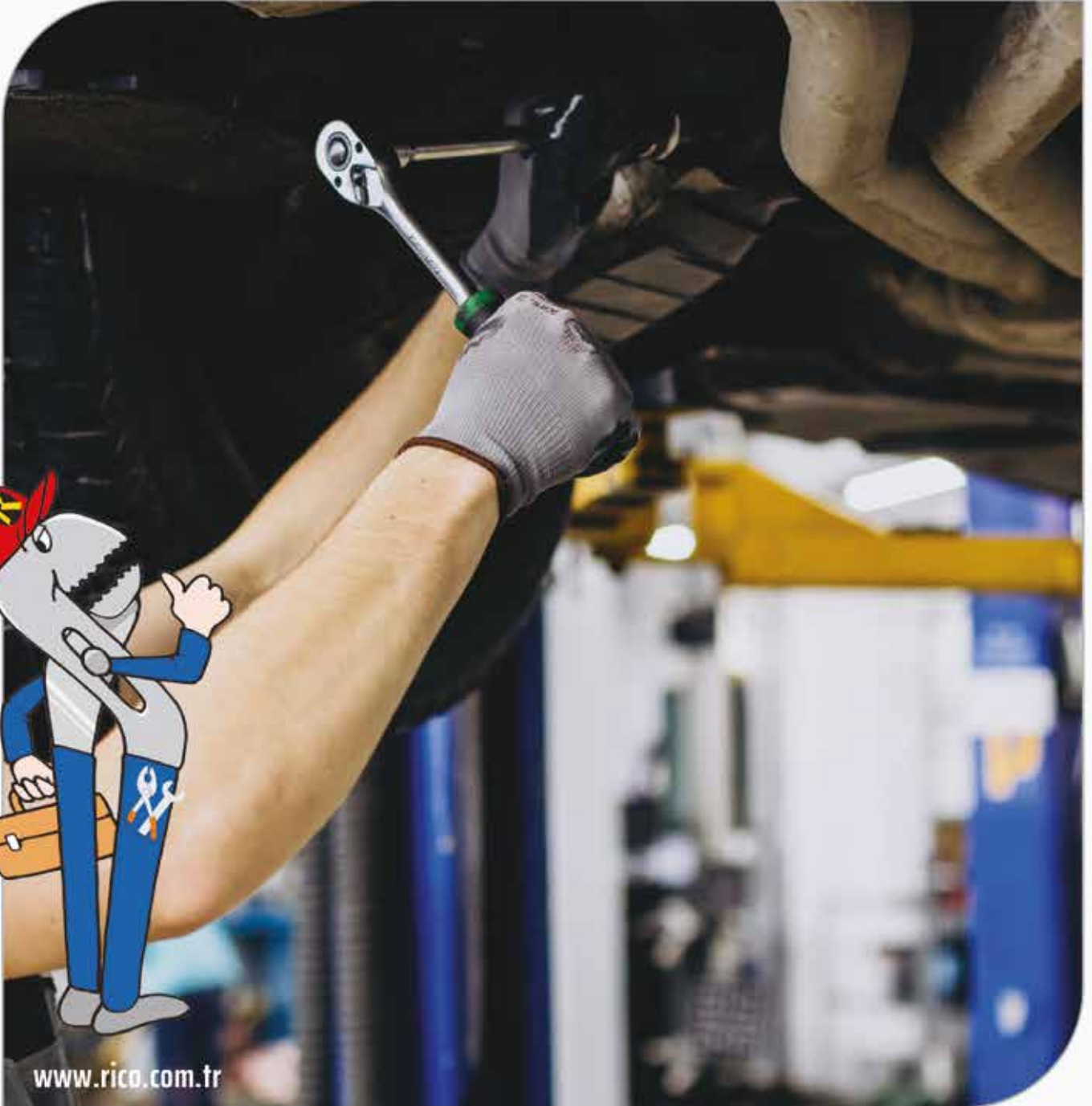

www.rico.com.tr

110PCS 1/2" & 1/4" 6PT SOCKET SET

110 PARÇA 1/2" - 1/4" **6 KÖŞE LOKMA TAKIMI**



KOD	ÜRÜN	1	2	FİYAT
006-RC1011	110PC 1/2" & 1/4" 6 Köşe Lokma Takımı	1	2	245,00 \$

İÇİNDEKİLER

*13PC 1/4"	Dr.6 Köşe Lokma:	4, 4.5, 5, 5.5, 6, 7, 8, 9, 10, 11, 12, 13, 14mm
*8PC 1/4"	6 Köşe Derin Lokma:	6, 7, 8, 9, 10, 11, 12, 13mm
*18PC 1/4"	Bits Lokma (37mmL):	SL4, SL5.5, SL6.5, PH1, PH2, PZ1, PZ2, H3, H4, H5, H6, T8, T10, T15, T20, T25, T27, T30 E4, E5, E6, E7, E8, E10, E11
*7PC 1/4"	E Lokma:	10, 11, 12, 13, 14, 15, 16, 17, 18, 19, 20, 21, 22, 24, 27, 30, 32mm
*17PC 1/2"	6 Köşe Lokma:	10, 13, 14, 15, 17, 19, 22mm
*7PC 1/2"	6 Köşe Derin Lokma:	T20H, T25H, T27H, T30H, T35H, T40H, T45H, T50H (Kalınlık: 10mm)
*8PC 1/2"	Delikli Torx Lokma (55mmL):	
*2 PC 1/2"	Buji Lokma: 16 & 21mm	
*1 PC 1/4"	90T Diş Cırcır Kolu	
*1 PC 1/2"	90T Diş Cırcır Kolu	
*2 PC 1/4"	Uzatma, 50mm & 100mmL	
*2 PC 1/2"	Uzatma, 125mm & 250mmL	
*1 PC 1/4"	Oynar Mafsal	
*1 PC 1/2"	Oynar Mafsal	
*1 PC 1/4"	T-Kol, 115mmL	
*1 PC 1/4"	Lokma Tutucu Adaptör, 150mmL	
*1 PC 1/4"	Flex Uzatma, 150mmL	
*1 PC 3/8"	1/2" 3 lü Adaptör	
*1 PC 1/2"	Bits Tutucu, 10mm	
*17PC	Bits 10mm x 30mmL:	SL8, SL10, SL12; T40, T45, T50, T55, T60, PH3, PH4, PZ3, PZ4, H7, H8, H10, H12, H14

60PCS 1/4" 6 PT SOCKET SET

60 PARÇA 1/4" **6 KÖŞE LOKMA SETİ**



KOD	ÜRÜN	1	5	FİYAT
006-RC1012	60PC 1/4" 6 Köşe Lokma Seti	1	5	90,00 \$

İÇİNDEKİLER

*13PC 1/4"	6 Köşe Lokma:	4, 4.5, 5, 5.5, 6, 7, 8, 9, 10, 11, 12, 13, 14mm
*8PC 1/4"	6 Köşe Derin Lokma:	6, 7, 8, 9, 10, 11, 12, 13mm
*7PC 1/4"	E Lokma:	E4, E5, E6, E7, E8, E10, E11
*24PC 1/4"	Bits Lokma:	SL4, SL5.5, SL6.5, H3, H4, H5, H6, H7, H8, T8, T10, T15, T20, T25, T27, T30, T35, T40, PH1, PH2, PH3, PZ1, PZ2, PZ3 150mm 100mm, 50mm (L)
*3 PC 1/4"	Mafsalı Uzatma:	
*1 PC 1/4"	T- Kol: 115mm (L)	
*1 PC 1/4"	Oynar Mafsal	*1 PC 1/4" Lokma Tutucu Adaptör 150 mm (L)
*1 PC 1/4"	90 Diş Cırcır Kolu	*1 PC 1/4" Flex Uzatma 150 mm (L)

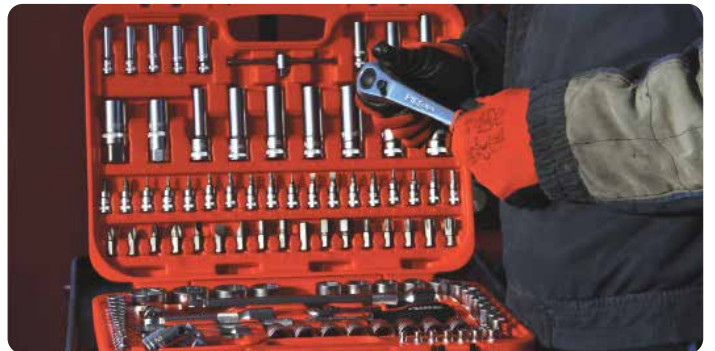

25PCS 1/2" 6 & 12 PT SOCKET SET

25 PARÇA 1/2" 6 & 12 KÖŞE LOKMA SETİ



KOD	ÜRÜN	📦	📦	FİYAT
006-RC1126	25PC 1/2" Lokma Seti 6 Köşe	1	5	125,00 \$
006-RC1225	25PC 1/2" Lokma Seti 12 Köşe	1	5	125,00 \$

İÇİNDEKİLER

- * 10 mm, 11 mm, 12 mm, 13 mm, 14 mm, 15 mm, 16 mm, 17 mm, 18 mm, 19 mm, 20 mm, 21 mm, 22 mm, 24 mm, 27 mm, 30 mm, 32 mm
- * 1/2" Buji lokma 16 mm, 19 mm, 21 mm
- * 1/2" Uzatma 125 mm
- * 1/2" Uzatma 250 mm
- * 1/2" Cırcır kolu
- * 1/2" T Kol 250 mm
- * 1/2" Oynar mafsalsal
- * Takım Çantası

30PCS 1/2" 6 & 12 PT SOCKET SET

30 PARÇA 1/2" 6 & 12 KÖŞE LOKMA SETİ



KOD	ÜRÜN	📦	📦	FİYAT
006-RC1330	30PC 1/2" Lokma Seti 6 Köşe	1	4	154,00 \$
006-RC1331	30PC 1/2" Lokma Seti 12 Köşe	1	4	154,00 \$

İÇİNDEKİLER

- 1/2" Lokma : 8, 9, 10, 11, 12, 13, 14, 15, 16, 17, 18, 19, 20, 21, 22, 24, 27, 29, 30, 32mm
- 1/2" 72 Diş Cırcır Kolu
- 1/2" Mafsalsal Uzatma: 75, 125, 250 mm
- 1/2" T-Kol 250 mm
- 1/2" Buji Lokma: 16, 19, 21mm
- 1/2" Oynar Mafsalsal
- 1/2" Fir Döndü 410mm (L)

19PCS 3/4" 6 & 12 PT SOCKET SET

19 PARÇA 3/4" 6 & 12 KÖŞE AĞIR LOKMA SETİ



KOD	ÜRÜN	📦	📦	FİYAT
006-RC1021	19PC 3/4" Ağır Lokma Set 6 Köşe	1	1	440,00 \$
006-RC1022	19PC 3/4" Ağır Lokma Set 12 Köşe	1	1	440,00 \$

İÇİNDEKİLER

- * 21 mm, 22 mm, 24 mm, 27 mm, 30 mm, 32 mm, 36 mm, 38 mm, 41 mm, 46 mm, 50 mm, 55 mm, 60 mm
- * 3/4" Uzatma 100 ve 200 mm (L)
- * 3/4" FX 1/2" M Adaptör
- * 3/4" T Kol
- * 3/4" Cırcır kolu 500 mm (L)
- * Takım Çantası

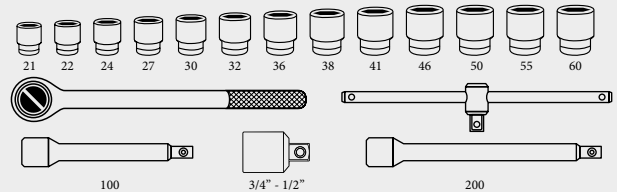

16PCS 1/4" SOCKET SET EXTENDED RATCHET

16PC 1/4" **LOKMA SETİ UZATMALI CIRCİR**



16PCS 1/4" 6 PT SOCKET SET

16PC 1/4" **LOKMA SETİ 4 - 13 MM**



KOD	ÜRÜN	1	10	FİYAT
006-RC1017	16PC 1/4" Lokma Seti 4-13mm	1	10	53,00 \$

KOD	ÜRÜN	1	10	FİYAT
006-RC1014	16PC 1/4" Lokma Seti 4-13mm	1	10	50,00 \$

İÇİNDEKİLER

* 4 mm, 5 mm, 6 mm, 7 mm, 8 mm, 10 mm, 11 mm, 12 mm, 13 mm * Takım Çantası
* 1/4" Cırcır Kolu Uzatmalı 72 Diş* 1/4" Uzatma 50 ve 150 * 1/4" Oynar Mafsal * 1/4" Lokma Tutucu

İÇİNDEKİLER

* 4 mm, 5 mm, 6 mm, 7 mm, 8 mm, 10 mm, 11 mm, 12 mm, 13 mm * 1/4" Cırcır Kolu 48 Diş
* 1/4" Uzatma 50 ve 150 * 1/4" Oynar Mafsal * 1/4" Lokma Tutucu * Takım Çantası

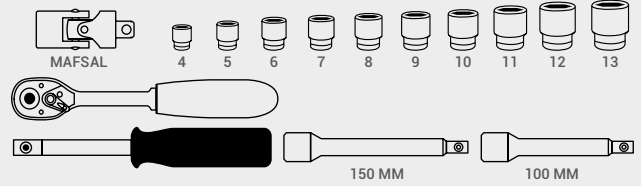
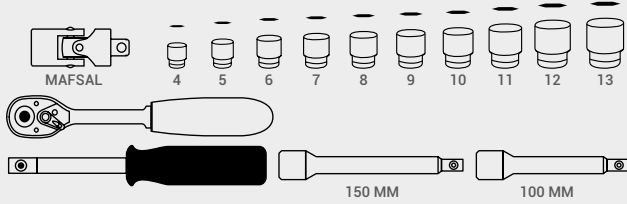

24PCS 3/8" 6 PT SOCKET SET

24 PARÇA 3/8" **LOKMA SETİ**



24PCS 3/8" 6 PT SOCKET SET

24 PARÇA 3/8" **UZATMALI CIRCİR LOKMA SETİ**



KOD	ÜRÜN	1	6	FİYAT
007-RC3028	3/8" 24PC Lokma Seti 10-22mm	1	6	90,00 \$

KOD	ÜRÜN	1	6	FİYAT
007-RC2326	3/8" 24 Parça Uzatmalı Cırcır Lokma Seti	1	6	93,00 \$

İÇİNDEKİLER

* 17PC - 3/8" 6 Köşe Lokma: 6, 7, 8, 9, 10, 11, 12, 13, 14, 15, 16, 17, 18, 19, 20, 21, 22mm
* 2PC - 3/8" Mafsalı Uzatma: 75mm (L) & 150mm (L)
* 2PC - 3/8" Buji Lokma: 16, 21mm
* 1PC - 3/8" Oynar Mafsal
* 1PC - 3/8" T Kol: 200 mm (L)
* 1PC - 3/8" 72 Diş Cırcır Kolu

İÇİNDEKİLER

* 17PC - 3/8" 6 Köşe Lokma: 6, 7, 8, 9, 10, 11, 12, 13, 14, 15, 16, 17, 18, 19, 20, 21, 22mm
* 2PC - 3/8" Mafsalı Uzatma: 75mm (L) & 150mm (L)
* 2PC - 3/8" Buji Lokma: 16, 21mm
* 1PC - 3/8" Oynar Mafsal
* 1PC - 3/8" 72 Diş Uzatmalı Cırcır Kolu

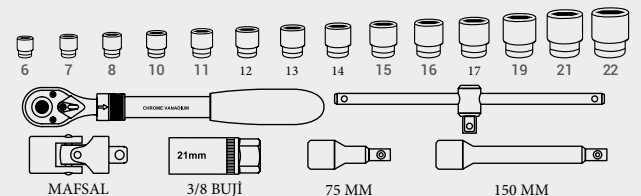
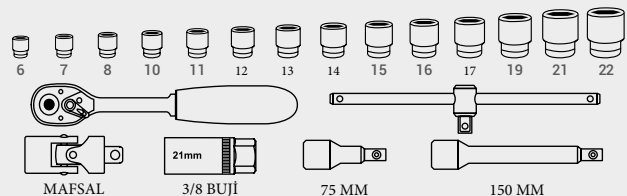

40PCS 1/4" SOCKET BITS SET

40 PARÇA 1/4" LOKMALI BITS SET



KOD	ÜRÜN	📦	📦	FİYAT
007-RC4513	40PC 1/4" Lokmalı Bits Set	1	10	50.00 \$

İÇİNDEKİLER

- * Lokma: 5.5mm, 6mm, 7mm, 8mm, 9mm, 10mm, 11mm, 12mm, 13mm
- * E Lokma: 4mm, 5mm, 6mm, 7mm, 8mm, 10mm, 11mm
- * Allen Lokma: H3, H4, H5, H6, H7, H8, H10
- * Torx Lokma: T-10, T-15, T-20, T-25, T-27, T-30, T35, T40
- * Bits Lokma: PZ1, PZ2, PH1, PH2, SL5, SL6
- * Lokma Tutucu Tornavida * 1/4" Uzatma 100mm * 1/4" T Kol

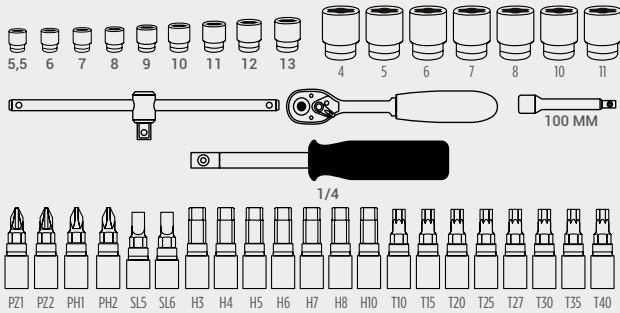

40PCS 1/4" SOCKET SET

40 PARÇA 1/4" LOKMA SETİ



KOD	ÜRÜN	📦	📦	FİYAT
007-RC4512	40PC 1/4" Lokma Seti	1	10	60.00 \$

İÇİNDEKİLER

- * Lokma: 4mm, 4.5mm, 5mm, 5.5mm, 6mm, 7mm, 8mm, 9mm, 10mm, 11mm, 12mm, 13mm
- * Allen: 1.25mm, 1.5mm, 2mm, 2.5mm, 3mm
- * 1/4" Cırcir Kolu 72 Diş
- * 1/4" Uzatma 50
- * 1/4" Uzatma 150
- * 1/4" Dynar Mafsals
- * T Kol

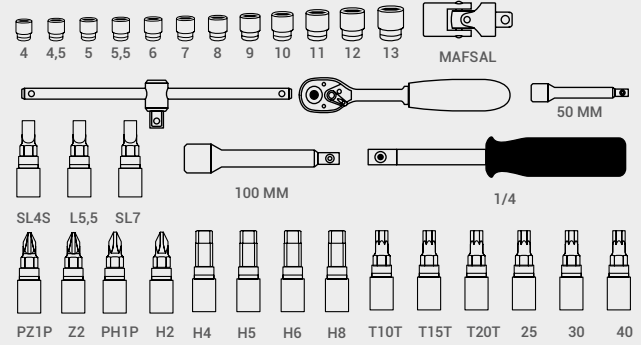

SPARK PLUG BAR

T. MAFSALLI BUJİ ANAHTARI 16-21MM

KOD	ÜRÜN	📦	📦	FİYAT
007-RC5222	T. Mafsallı Bujî Anahtarı 16-21mm	10	60	8,50 \$



18PCS 1/4" - 1/2" TORX SOCKET SET

18 PARÇA 1/4" - 1/2" **TORX LOKMA SETİ**



KOD	ÜRÜN	1	20	FİYAT
007-RC9018	18PC 1/4" - 1/2" Torx Lokma Seti	1	20	60,00 \$

İÇİNDEKİLER

- * E4, E5, E6, E7, E8, E10 (1/4" Torx Lokma)
- * E10, E11, E12, E14, E16, E18, E20, E22 (1/2" Torx Lokma)
- * T30, T40, T45 (1/2" Bits Uçlu Torx Lokma)
- * Takım Çantası

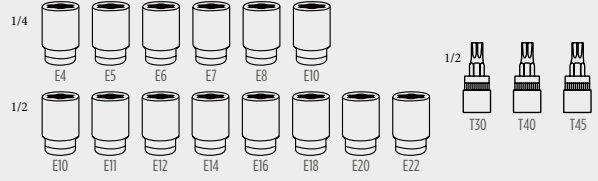

10PCS 1/2" TORX SOCKET SET

10 PARÇA 1/2" **TORX LOKMA SETİ**



KOD	ÜRÜN	1	10	FİYAT
007-RC4510	10PC 1/2" Torx Lokma Seti (Erkek)	1	10	44,00 \$

İÇİNDEKİLER

- * T20, T25, T27, T30, T40, T45, T50, T55, T60, T70
- * Takım Çantası

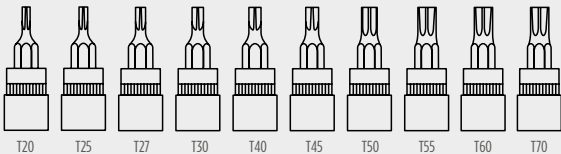

10PCS 1/2" HEX SOCKET SET

10 PARÇA 1/2" **ALLEN LOKMA SETİ**



KOD	ÜRÜN	1	15	FİYAT
007-RC4511	10PC 1/2" Allen Lokma Seti	1	15	48,00 \$

İÇİNDEKİLER

- * 4mm, 5mm, 6mm, 7mm, 8mm, 10mm, 12mm, 14mm, 17mm, 19mm
- * Takım Çantası

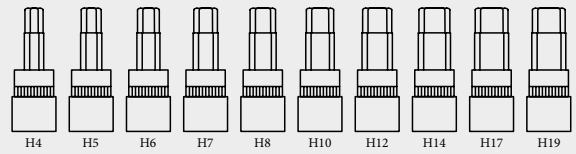

8PCS 1/2" ALLEN DEEP SOCKET SET

8 PARÇA 1/2" ALLEN LOKMA SETİ UZUN



KOD	ÜRÜN	1	20	FİYAT
007-RC1161	8PC 1/2" Allen Lokma Seti Uzun	1	20	52,00 \$

İÇİNDEKİLER

* 4 mm, 5 mm, 6 mm, 7 mm, 8 mm, 10 mm, 12 mm, 14 mm

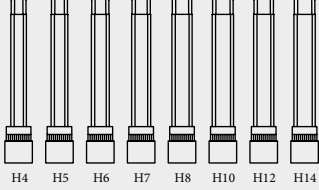

1/2" E TYPE DEEP STAR SOCKET SET

9 PARÇA 1/2" İÇ TORX E LOKMA SETİ UZUN

KOD	ÜRÜN	1	10	FİYAT
007-RC7014	9PC 1/2" İç Torx E Lokma Seti	1	10	53,00 \$

İÇİNDEKİLER

* E10, E11, E12, E14, E16, E18, E20, E22, E24 * Takım Çantası

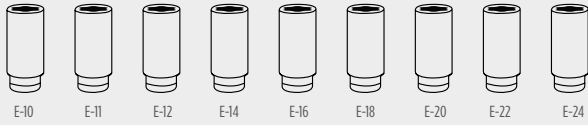

9PCS 1/2" E-TYPE SOCKET SET FEMALE

9 PARÇA 1/2" İÇ TORX E LOKMA SETİ KISA

KOD	ÜRÜN	1	20	FİYAT
007-RC9010	9PC 1/2" İç Torx E Lokma Seti	1	20	36,00 \$

İÇİNDEKİLER

* E10, E11, E12, E14, E16, E18, E20, E22, E24 * Takım Çantası

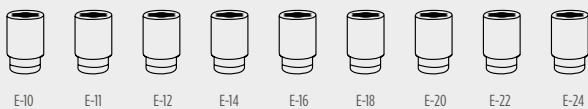

12PCS 1/2" SPLINE BIT SOCKET SET

12PC 1/2" M TİPİ TORX LOKMA SETİ

12PCS 1/2" DEEP SOCKET SET 6 PT / 12 PT

12 PARÇA 1/2" 6 & 12 KÖŞE UZUN LOKMA SETİ

12PCS 1/2" DEEP IMPACT SOCKET SET

12 PARÇA HAVALI DERİN LOKMA SETİ

KOD	ÜRÜN	1	8	FİYAT
007-RC7004	12PC 1/2" M Tipi Torx Lokma Seti	1	8	65,00 \$

İÇİNDEKİLER

* 55L - M6, M8, M10, M12, M14, M16

* 100L - M8, M10, M12, M14, M16 M18

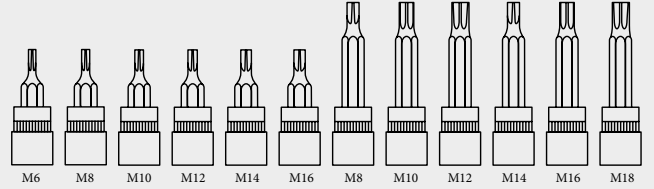

KOD	ÜRÜN	1	10	FİYAT
007-RC12125D	12PC 1/2" Uzun Lokma Seti 6 Köşe	1	10	62,00 \$
007-RC11135D	12PC 1/2" Uzun Lokma Seti 12 Köşe	1	6	62,00 \$

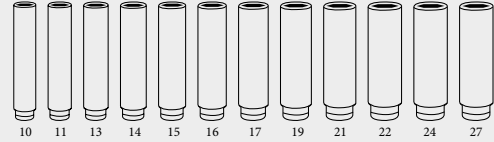
İÇİNDEKİLER* 10 mm, 11 mm, 13 mm, 14 mm, 15 mm, 16 mm, 17 mm, 19 mm, 21 mm, 22 mm, 24 mm, 27 mm
* Takım Çantası

KOD	ÜRÜN	1	8	FİYAT
022-RC2333	1/2" 12PC Havalı Derin Set	1	8	74,00 \$

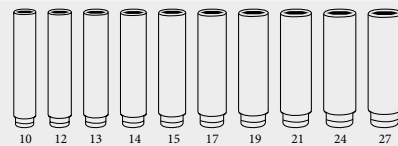
İÇİNDEKİLER10-12-13-14-15-17-19-21-24-27
3/4-1/2 Havalı Adaptör
1/2 Havalı Oynar Mafsal

10PCS 1/4" 6 PT DEEP SOCKET SET 4 - 13 MM

10 PARÇA 1/4" 6 KŞ **UZUN LOKMA SET 4 - 13 MM**

KOD	ÜRÜN	📦	📦	FİYAT
006-RC1010	10PC 1/4" 6 Köşe Uzun Lokma Set 4 - 13mm	1	20	21,00 \$

İÇİNDEKİLER

* 4 mm, 5 mm, 6 mm, 7 mm, 8 mm, 10 mm, 11 mm, 12 mm, 13 mm, * 1/4" Lokma tutucu
* Takım Çantası

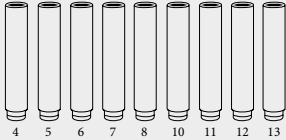

1/4" Lokma tutucu

18PCS 1/4" 6 PT DEEP SOCKET SET

18PC 1/4" 6 KŞ **UZUN LOKMA SETİ**

KOD	ÜRÜN	📦	📦	FİYAT
007-RC1418	18PC 1/4" 6 Köşe Uzun Lokma Seti	1	10	50,00 \$

İÇİNDEKİLER

* 1/4" 4 mm, 5 mm, 6 mm, 7 mm, 8 mm, 9 mm, 10 mm, 11 mm, 12 mm, 13 mm, 14 mm
* 1/4" Lokma tutucu * 1/4" T kol * 1/4" Uzatma 100 * 1/4" Oynar mafsal * Takım Çantası

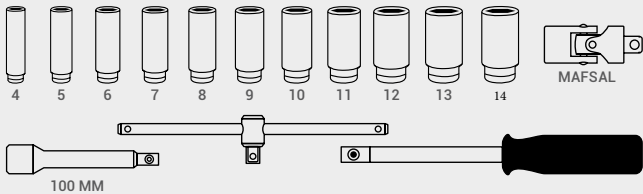

100 MM

10PCS 1/2" 6 PT RIBE BIT S. 5.5 CM

10PC 1/2" **RIBE LOKMA SETİ 5.5 CM 6 KÖŞE**

KOD	ÜRÜN	📦	📦	FİYAT
007-RC9804	10PC 1/2" Ribe Lokma Seti 5.5cm 6 Köşe	1	16	38,00 \$

İÇİNDEKİLER

* R4, R5, R6, R7, R8, R9, R10, R12, R13, R14 * Takım Çantası

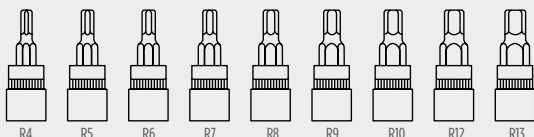

R4

R5

R6

R7

R8

R9

R10

R12

R13



11PCS 1/4" - 1/2" 5 PT TAMPERPROOF STAR BIT S. SET

11PC **TORX LOKMA SETİ 5 KÖŞE DELİKLİ**



11PCS 1/4" - 1/2" 5 PT STAR BIT SOCKET SET

11PC 1/4" - 1/2" **TORX LOKMA SETİ 5 KÖŞE**



20PCS 1/4" & 1/2" TAMPER BIT SOCKET SET

20 PARÇA 1/4" & 1/2" **DELİKLİ TORX LOKMA SET**



KOD	ÜRÜN	1	20	FİYAT
007-RC9801	11PC 1/4" 1/2" Torx L. Seti (5 Köşe Delikli)	1	20	38,00 \$

İÇİNDEKİLER

* 1/4" TS10H, TS15H, TS20H, TS25H, TS27H, TS30H 1/2" TS40H, TS45H, TS50H, TS55H, TS60H
* Takım Çantası

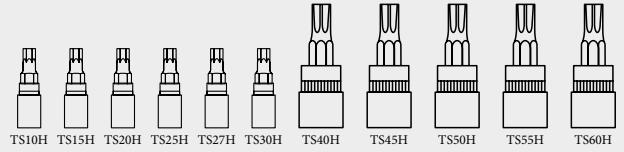

KOD	ÜRÜN	1	20	FİYAT
007-RC9802	11PC 1/4" - 1/2" Torx Lokma Seti 5 Köşe	1	20	38,00 \$

İÇİNDEKİLER

* 1/4" TS10, TS15, TS20, TS25, TS27, TS30, 1/2" TS40, TS45, TS50, TS55, TS60 * Takım Çantası

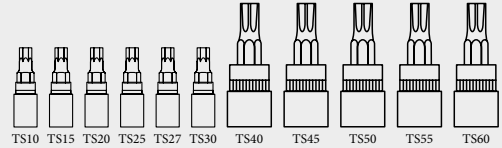

KOD	ÜRÜN	1	10	FİYAT
007-RC3029	1/4" - 1/2" 20PC Delikli Torx Lokma Seti	1	10	70,00 \$

İÇİNDEKİLER

* 6PC 1/4" Delikli Torx Lokma 37 mm (T8, T10, T15, T20, T25, T27)
* 7PC 1/2" Delikli Torx Lokma 55mm (T30, T35, T40, T45, T50, T55, T60)
* 7PC 1/2" Delikli Torx Lokma 100mm (T30, T35, T40, T45, T50, T55, T60)

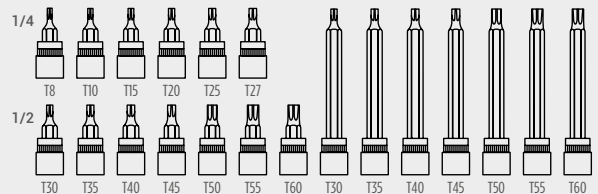

8PCS 1/4" STAR BIT SOCKET SET

8 PARÇA 1/4" **LOKMALI TORX UÇ SETİ**



KOD	ÜRÜN	12	72	FİYAT
007-RC7023	8PC 1/4" Lokmalı Torx Uç Seti	12	72	13,20 \$

İÇİNDEKİLER

* 1/4" T10, T15, T20, T25, T27, T30, T35, T40

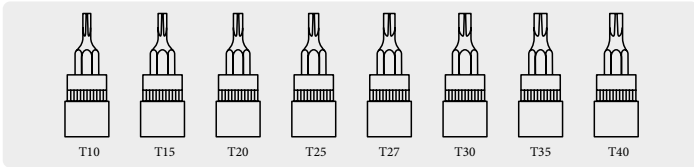

8PCS 1/4" TAMPER STAR BIT SOCKET SET

8 PARÇA 1/4" **LOKMALI DELİKLİ TORX UÇ SETİ**

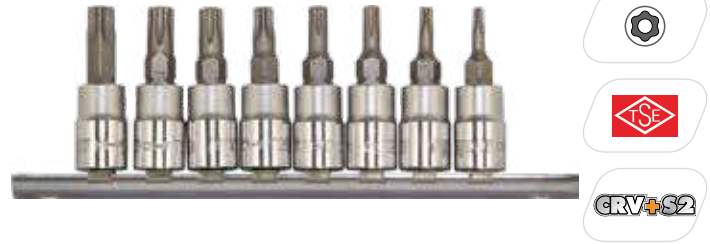

KOD	ÜRÜN	12	72	FİYAT
007-RC7024	8PC 1/4" Lokmalı Delikli Torx Uç Seti	12	72	14,70 \$

İÇİNDEKİLER

* 1/4" T10, T15, T20, T25, T27, T30, T35, T40

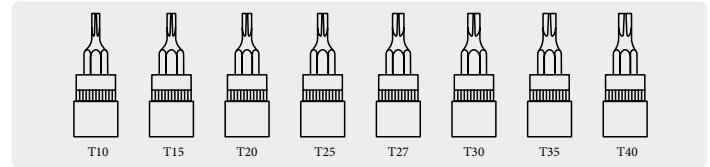

7 PCS 1/4" HEX BIT SOCKET SET

7 PARÇA 1/4" **LOKMALI ALLEN UÇ SETİ**



KOD	ÜRÜN	12	72	FİYAT
007-RC7028	7PC Lokmalı Allen Uç Seti	12	72	12,00 \$

İÇİNDEKİLER

* 1/4" H3, H4, H5, H6, H7, H8, H10

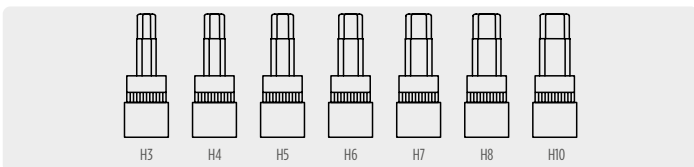

7 PCS 1/4" E TYPE SOCKET SET

7 PARÇA 1/4" **İÇ TORX E LOKMA SETİ**



KOD	ÜRÜN	10	40	FİYAT
007-RC1407	7PC 1/4" İç Torx E Lokma Seti	10	40	12,00 \$

İÇİNDEKİLER

* 1/4" E4, E5, E6, E7, E8, E10, E11

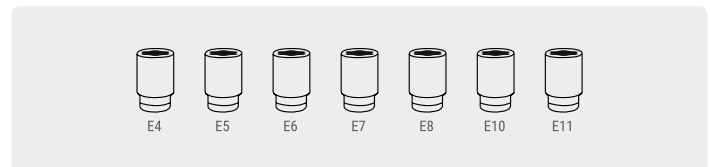

1/4" STAR BIT SOCKET 37MM

1/4" LOKMALI TORX UÇ KISA



KOD	ÜRÜN	📦	📦	FİYAT
007-RC7015	T-10	15	1200	1,50 \$
007-RC7016	T-15	15	1200	1,50 \$
007-RC7017	T-20	15	1200	1,50 \$
007-RC7018	T-25	15	1200	1,50 \$
007-RC7019	T-27	15	1200	1,50 \$
007-RC7020	T-30	15	1200	1,50 \$
007-RC7021	T-35	15	1200	1,50 \$
007-RC7022	T-40	15	1200	1,50 \$



1/4" TORX SOCKET E TYPE

1/4" İÇ TORX LOKMA



KOD	ÜRÜN	📦	📦	FİYAT
007-RC1604	E-4	20	400	1,50 \$
007-RC1605	E-5	20	400	1,50 \$
007-RC1606	E-6	20	400	1,50 \$
007-RC1607	E-7	20	400	1,50 \$
007-RC1608	E-8	20	400	1,50 \$
007-RC1610	E-10	20	400	1,50 \$



1/4" TAMPER STAR BIT SOCKET

1/4" LOKMALI TORX UÇ KISA DELİKLİ



KOD	ÜRÜN	📦	📦	FİYAT
007-RC7033	T-10	15	1200	1,65 \$
007-RC7029	T-15	15	1200	1,65 \$
007-RC7030	T-20	15	1200	1,65 \$
007-RC7031	T-25	15	1200	1,65 \$
007-RC7032	T-27	15	1200	1,65 \$
007-RC7034	T-30	15	1200	1,65 \$
007-RC7035	T-35	15	1200	1,65 \$
007-RC7036	T-40	15	1200	1,65 \$



1/4" 5 PT STAR TAMPERPROOF BIT SOCKET

1/4" TORX LOKMA KISA UÇ DELİKLİ 5 KÖŞE



KOD	ÜRÜN	📦	📦	FİYAT
007-RC1620	LTS20H	20	200	1,65 \$
007-RC1621	LTS25H	20	200	1,65 \$
007-RC1622	LTS27H	20	200	1,65 \$
007-RC1623	LTS30H	20	200	1,65 \$



1/4" HEX BIT SOCKET W/PVC

1/4" LOKMALI ALLEN UÇ KISA



KOD	ÜRÜN	📦	📦	FİYAT
007-RC7037	3mm	15	1200	1,60 \$
007-RC7025	4mm	15	1200	1,60 \$
007-RC7026	5mm	15	1200	1,75 \$
007-RC7027	6mm	15	1200	1,75 \$
007-RC7038	7mm	15	1200	2,00 \$
007-RC7039	8mm	15	1200	2,00 \$
007-RC7040	10mm	15	1200	2,30 \$



1/4" SOCKET SHORT TYPE

1/4" KISA LOKMA 6 KÖŞE



KOD	ÜRÜN	📦	📦	FİYAT
007-RC3806	6 mm	20	400	0,90 \$
007-RC3807	7 mm	20	400	0,95 \$
007-RC3808	8 mm	20	400	0,98 \$
007-RC3809	9 mm	20	400	1,00 \$
007-RC3810	10 mm	10	200	1,05 \$
007-RC3811	11 mm	10	200	1,05 \$
007-RC3812	12 mm	10	200	1,12 \$
007-RC3813	13 mm	10	200	1,19 \$



3/8" 6 PT SOCKET

3/8" **6 KÖŞE LOKMA**



KOD	ÜRÜN	📦	📦	FİYAT
007-RC4808	8 mm	10	200	1,41 \$
007-RC4810	10 mm	10	200	1,45 \$
007-RC4811	11 mm	10	700	1,47 \$
007-RC4812	12 mm	10	200	1,50 \$
007-RC4813	13 mm	10	200	1,55 \$
007-RC4814	14 mm	10	200	1,63 \$
007-RC4815	15 mm	10	200	1,70 \$
007-RC4816	16 mm	10	200	1,80 \$
007-RC4817	17 mm	10	200	2,00 \$
007-RC4819	19 mm	10	200	2,45 \$



1/2" SOCKET T-TYPE

1/2" **BİTS UÇLU TORX LOKMA KISA**



KOD	ÜRÜN	📦	📦	FİYAT
007-RC9070	T-20	10	200	2,95 \$
007-RC9080	T-25	10	200	3,05 \$
007-RC9081	T-27	10	200	3,10 \$
007-RC9090	T-30	10	200	3,17 \$
007-RC9091	T-35	10	200	3,25 \$
007-RC9100	T-40	10	200	3,35 \$
007-RC9200	T-45	10	200	3,40 \$
007-RC9300	T-50	10	200	3,45 \$
007-RC9400	T-55	10	200	3,85 \$
007-RC9500	T-60	10	100	3,95 \$
007-RC9510	T-70	10	100	4,10 \$



1/4" DEEP SOCKET 6 PT

1/4" **UZUN LOKMA 6 KÖŞE**



KOD	ÜRÜN	📦	📦	FİYAT
007-RC4004	4 mm	10	400	1,35 \$
007-RC4005	5 mm	10	400	1,35 \$
007-RC3105	5,5 mm	10	400	1,35 \$
007-RC3025	6 mm	10	400	1,50 \$
007-RC4007	7 mm	10	400	1,50 \$
007-RC4008	8 mm	10	400	1,50 \$
007-RC4009	9 mm	10	200	1,65 \$
007-RC4010	10 mm	10	200	1,65 \$
007-RC4011	11 mm	10	200	1,65 \$
007-RC4012	12 mm	10	200	1,85 \$
007-RC4013	13 mm	10	200	1,85 \$
007-RC3014	14 mm	8	160	1,95 \$



1/2" SOCKET T-TYPE

1/2" **BİTS UÇLU TORX LOKMA UZUN**



KOD	ÜRÜN	📦	📦	FİYAT
007-RC9507	T-20	10	200	3,85 \$
007-RC9508	T-25	10	200	3,95 \$
007-RC9509	T-27	10	200	4,05 \$
007-RC9501	T-30	10	200	4,10 \$
007-RC9511	T-35	10	200	4,15 \$
007-RC9502	T-40	10	200	4,20 \$
007-RC9503	T-45	10	200	4,25 \$
007-RC9504	T-50	10	200	4,42 \$
007-RC9505	T-55	10	200	4,60 \$
007-RC9506	T-60	10	200	5,05 \$
007-RC9512	T-70	10	200	5,52 \$



1/4" DEEP SOCKET 12 PT

1/4" **UZUN LOKMA 12 KÖŞE**



KOD	ÜRÜN	📦	📦	FİYAT
007-RC4108	8 mm	10	400	1,60 \$
007-RC4109	9 mm	10	200	1,70 \$
007-RC4110	10 mm	10	200	1,75 \$
007-RC4113	13 mm	10	200	2,05 \$



1/2" SPARK PLUG SOCKET

1/2" **BUJİ LOKMASI**



KOD	ÜRÜN	📦	📦	FİYAT
007-RC3016	16 mm	10	160	3,32 \$
007-RC3017	17 mm	10	160	3,80 \$
007-RC3019	19 mm	10	160	4,15 \$
007-RC3021	21 mm	10	160	4,60 \$
007-RC3022	22 mm	10	80	5,25 \$



1/2" M TYPE SOCKET 100 MM

1/2" M TİPİ LOKMA 100MM



KOD	ÜRÜN	📦	📦	FİYAT
007-RC5606	6 mm	10	100	4,20 \$
007-RC5608	8 mm	10	100	4,45 \$
007-RC5610	10 mm	10	100	4,70 \$
007-RC5612	12 mm	10	60	5,15 \$
007-RC5614	14 mm	10	60	5,75 \$
007-RC5616	16 mm	10	60	6,70 \$
007-RC5618	18 mm	10	60	8,90 \$



1/2" M TYPE SOCKET 58MM

1/2" M TİPİ LOKMA 58MM



KOD	ÜRÜN	📦	📦	FİYAT
007-RC5506	6 mm	10	100	3,45 \$
007-RC5508	8 mm	10	100	3,60 \$
007-RC5510	10 mm	10	100	3,85 \$
007-RC5512	12 mm	10	100	4,10 \$
007-RC5514	14 mm	10	100	4,50 \$
007-RC5516	16 mm	10	100	5,15 \$



1/2" HEX TYPE ALLEN SOCKET LONG TYPE

1/2" ALLEN LOKMA 100 MM



KOD	ÜRÜN	📦	📦	FİYAT
007-RC1204	4 mm	10	100	3,90 \$
007-RC1205	5 mm	10	100	4,05 \$
007-RC1206	6 mm	10	100	4,15 \$
007-RC1207	7 mm	10	100	4,25 \$
007-RC1208	8 mm	10	100	4,35 \$
007-RC1310	10 mm	10	100	4,50 \$
007-RC1312	12 mm	10	60	5,40 \$
007-RC1314	14 mm	10	60	6,10 \$
007-RC1316	16 mm	10	60	6,70 \$
007-RC1326	17 mm	10	60	7,30 \$
007-RC1327	19 mm	10	60	8,75 \$



1/2" ALLEN SOCKET 58 MM SHORT

1/2" ALLEN LOKMA 58 MM



KOD	ÜRÜN	📦	📦	FİYAT
007-RC1317	4 mm	10	200	2,85 \$
007-RC1318	5 mm	10	200	2,95 \$
007-RC1319	6 mm	10	200	3,00 \$
007-RC1320	7 mm	10	200	3,05 \$
007-RC1321	8 mm	10	200	3,15 \$
007-RC2310	10 mm	10	200	3,35 \$
007-RC1322	12 mm	10	200	3,55 \$
007-RC2314	14 mm	10	200	4,00 \$
007-RC1323	16 mm	10	200	4,65 \$
007-RC1324	17 mm	10	200	5,40 \$
007-RC1325	19 mm	10	200	5,90 \$



1/2" RİBE BİT SOCKET 12 CM 6 PT

1/2" RİBE LOKMA 12 CM 6 KÖŞE



KOD	ÜRÜN	📦	📦	FİYAT
007-RC9599	7 mm	10	100	3,90 \$
007-RC9600	8 mm	10	100	4,25 \$
007-RC9601	9 mm	10	100	4,40 \$
007-RC9700	10 mm	10	100	4,62 \$
007-RC9800	12 mm	10	100	4,85 \$



1/2" RİBE BIT SOCKET 5.5 CM 6 PT

1/2" RİBE LOKMA 5.5 CM



KOD	ÜRÜN	📦	📦	FİYAT
007-RC8600	8 mm	10	100	3,40 \$
007-RC8700	10 mm	10	100	3,60 \$
007-RC8800	12 mm	10	100	3,75 \$



ÜRÜN ÖZELLİKLERİ

Yüksek Kaliteli CRV Çeliğinden Üretilmiştir. Bits Uçlar S2 Çeliğinden Üretilmiştir.
Parlak Krom Kaplama, Polisajlanmış Yüzeyler

ÜRÜN ÖZELLİKLERİ

Yüksek Kaliteli CRV Çeliğinden Üretilmiştir.
Bits Uçlar S2 Çeliğinden Üretilmiştir
Parlak Krom Kaplama
Polisajlanmış Yüzeyler

1/2" 6 PT SOCKET

1/2" 6 KÖŞE LOKMA

KOD	ÜRÜN	📦	📦	FİYAT
007-RC8008	8 mm	10	200	2,00 \$
007-RC8009	9 mm	10	200	2,06 \$
007-RC8010	10 mm	10	200	2,11 \$
007-RC8011	11 mm	10	200	2,14 \$
007-RC8012	12 mm	10	200	2,19 \$
007-RC8013	13 mm	10	200	2,22 \$
007-RC8014	14 mm	10	200	2,28 \$
007-RC8015	15 mm	10	200	2,33 \$
007-RC8016	16 mm	10	200	2,39 \$
007-RC8017	17 mm	10	200	2,50 \$
007-RC8018	18 mm	10	200	2,72 \$
007-RC8019	19 mm	10	200	2,88 \$
007-RC8020	20 mm	10	200	3,22 \$
007-RC8021	21 mm	10	200	3,52 \$
007-RC8022	22 mm	10	100	3,69 \$
007-RC8024	24 mm	10	100	4,05 \$
007-RC8027	27 mm	10	100	5,20 \$
007-RC8030	30 mm	10	100	5,75 \$
007-RC8032	32 mm	10	100	6,30 \$



1/2" 6 PT DEEP SOCKET

1/2" 6 KÖŞE DERİN LOKMA

KOD	ÜRÜN	📦	📦	FİYAT
007-RC8108	8 mm	10	100	4,13 \$
007-RC8109	9 mm	10	100	4,16 \$
007-RC8110	10 mm	10	100	4,30 \$
007-RC8111	11 mm	10	100	4,33 \$
007-RC8112	12 mm	10	100	4,44 \$
007-RC8113	13 mm	10	100	4,46 \$
007-RC8114	14 mm	10	100	4,55 \$
007-RC8115	15 mm	10	100	4,61 \$
007-RC8116	16 mm	10	100	4,72 \$
007-RC8117	17 mm	10	100	4,83 \$
007-RC8118	18 mm	10	100	5,11 \$
007-RC8119	19 mm	10	100	5,27 \$
007-RC8120	20 mm	10	100	5,50 \$
007-RC8121	21 mm	10	60	5,65 \$
007-RC8122	22 mm	10	60	5,88 \$
007-RC8124	24 mm	10	50	6,22 \$
007-RC8127	27 mm	10	50	9,00 \$
007-RC8130	30 mm	10	40	9,90 \$
007-RC8132	32 mm	10	40	10,90 \$



1/2" 12 PT SOCKET

1/2" 12 KÖŞE LOKMA

KOD	ÜRÜN	📦	📦	FİYAT
007-RC1108	8 mm	10	200	2,00 \$
007-RC1209	9 mm	10	200	2,06 \$
007-RC1210	10 mm	10	200	2,11 \$
007-RC1211	11 mm	10	200	2,14 \$
007-RC1112	12 mm	10	200	2,19 \$
007-RC1213	13 mm	10	200	2,22 \$
007-RC1114	14 mm	10	200	2,28 \$
007-RC1215	15 mm	10	200	2,33 \$
007-RC1216	16 mm	10	200	2,39 \$
007-RC1217	17 mm	10	200	2,50 \$
007-RC1218	18 mm	10	200	2,72 \$
007-RC1219	19 mm	10	200	2,88 \$
007-RC1220	20 mm	10	200	3,22 \$
007-RC1221	21 mm	10	200	3,52 \$
007-RC1222	22 mm	10	200	3,69 \$
007-RC1224	24 mm	10	100	4,05 \$
007-RC1227	27 mm	10	100	5,20 \$
007-RC1230	30 mm	10	100	5,75 \$
007-RC1232	32 mm	10	100	6,30 \$



1/2" 12 PT DEEP SOCKET

1/2" 12 KÖŞE DERİN LOKMA

KOD	ÜRÜN	📦	📦	FİYAT
007-RC8208	8 mm	10	100	4,13 \$
007-RC8209	9 mm	10	100	4,16 \$
007-RC8210	10 mm	10	100	4,30 \$
007-RC8211	11 mm	10	100	4,33 \$
007-RC8212	12 mm	10	100	4,44 \$
007-RC8213	13 mm	10	100	4,46 \$
007-RC8214	14 mm	10	100	4,55 \$
007-RC8215	15 mm	10	100	4,61 \$
007-RC8216	16 mm	10	100	4,72 \$
007-RC8217	17 mm	10	100	4,83 \$
007-RC8218	18 mm	10	100	5,11 \$
007-RC8219	19 mm	10	100	5,27 \$
007-RC8220	20 mm	10	100	5,50 \$
007-RC8221	21 mm	10	60	5,65 \$
007-RC8222	22 mm	10	60	5,88 \$
007-RC8224	24 mm	10	50	6,22 \$
007-RC8227	27 mm	10	50	9,00 \$
007-RC8230	30 mm	10	40	9,90 \$
007-RC8232	32 mm	10	40	10,90 \$



1/2" DEEP TORX SOCKET E TYPE

1/2" İÇ TORX DERİN LOKMA



KOD	ÜRÜN	📦	📦	FİYAT
007-RC6999	E-8	10	200	4,56 \$
007-RC7005	E-10	10	200	4,62 \$
007-RC7006	E-11	10	200	4,67 \$
007-RC7007	E-12	10	200	4,72 \$
007-RC7008	E-14	10	200	4,77 \$
007-RC7009	E-16	10	200	4,95 \$
007-RC7010	E-18	10	200	5,00 \$
007-RC7011	E-20	10	200	6,10 \$
007-RC7012	E-22	10	200	6,35 \$
007-RC7013	E-24	10	100	6,70 \$



1/2" TORX SOCKET E TYPE

1/2" İÇ TORX LOKMA



KOD	ÜRÜN	📦	📦	FİYAT
007-RC9008	E-8	10	200	2,58 \$
007-RC9019	E-10	10	200	2,63 \$
007-RC9011	E-11	10	200	2,67 \$
007-RC9020	E-12	10	200	2,73 \$
007-RC9030	E-14	10	200	2,80 \$
007-RC9040	E-16	10	200	2,85 \$
007-RC9041	E-18	10	200	2,92 \$
007-RC9050	E-20	10	200	3,00 \$
007-RC9060	E-22	10	200	3,15 \$
007-RC9071	E-24	10	200	3,35 \$



3/4" 6 PT SOCKET

3/4" 6 KÖŞE AĞIR LOKMA

KOD	ÜRÜN	📦	📦	FİYAT
007-RC3417	17 mm	10	100	7,98 \$
007-RC3419	19 mm	10	100	8,15 \$
007-RC3421	21 mm	10	100	8,30 \$
007-RC3422	22 mm	10	100	8,40 \$
007-RC3424	24 mm	10	100	8,60 \$
007-RC3427	27 mm	10	100	8,98 \$
007-RC3428	28 mm	10	100	9,25 \$
007-RC3429	29 mm	10	100	9,40 \$
007-RC3430	30 mm	10	100	9,98 \$
007-RC3432	32 mm	10	100	10,50 \$
007-RC3433	33 mm	10	50	11,00 \$
007-RC3434	34 mm	10	50	11,75 \$
007-RC3435	35 mm	10	50	12,25 \$
007-RC3436	36 mm	10	50	13,50 \$
007-RC3438	38 mm	10	50	14,10 \$
007-RC3441	41 mm	10	50	16,00 \$
007-RC3446	46 mm	10	20	19,50 \$
007-RC3450	50 mm	10	20	22,50 \$
007-RC3455	55 mm	10	20	27,50 \$
007-RC3457	57 mm	10	20	31,50 \$
007-RC3460	60 mm	10	20	35,00 \$
007-RC3465	65 mm	5	10	40,00 \$
007-RC3470	70 mm	5	10	50,00 \$



3/4" 12 PT SOCKET

3/4" 12 KÖŞE AĞIR LOKMA

KOD	ÜRÜN	📦	📦	FİYAT
007-RC3517	17 mm	10	100	7,98 \$
007-RC3519	19 mm	10	100	8,15 \$
007-RC3521	21 mm	10	100	8,30 \$
007-RC3522	22 mm	10	100	8,40 \$
007-RC3524	24 mm	10	100	8,60 \$
007-RC3527	27 mm	10	100	8,98 \$
007-RC3528	28 mm	10	100	9,25 \$
007-RC3529	29 mm	10	100	9,40 \$
007-RC3530	30 mm	10	100	9,98 \$
007-RC3532	32 mm	10	100	10,50 \$
007-RC3533	33 mm	10	50	11,00 \$
007-RC3534	34 mm	10	50	11,75 \$
007-RC3535	35 mm	10	50	12,25 \$
007-RC3536	36 mm	10	50	13,50 \$
007-RC3538	38 mm	10	50	14,10 \$
007-RC3541	41 mm	10	50	16,00 \$
007-RC3546	46 mm	10	20	19,50 \$
007-RC3550	50 mm	10	20	22,50 \$
007-RC3555	55 mm	10	20	27,50 \$
007-RC3557	57 mm	10	20	31,50 \$
007-RC3560	60 mm	10	20	35,00 \$
007-RC3565	65 mm	5	10	40,00 \$
007-RC3570	70 mm	5	10	50,00 \$



3/8" F - 1/4" M SOCKET ADAPTER

3/8" F - 1/4" M **LOKMA ADAPTÖR**



3/4" F - 1/2" SOCKET ADAPTER

3/4" F - 1/2" M **LOKMA ADAPTÖR**



KOD	ÜRÜN	10	150	FİYAT
007-RC7418	3/8" F-1/4"	10	150	2,85 \$

KOD	ÜRÜN	5	80	FİYAT
007-RC7419	3/4" F-1/2"	5	80	7,70 \$

3/8" F - 1/2" M ADAPTER

3/8" F - 1/2" M **ADAPTÖR**



1/4" - 1/4" BIT ADAPTER

1/4" - 1/4" **BITS ADAPTÖR**



KOD	ÜRÜN	10	400	FİYAT
007-RC7413	3/8" F-1/2"	10	400	2,90 \$

KOD	ÜRÜN	10	400	FİYAT
007-RC7414	1/4-1/4"	10	400	2,40 \$

1/2" F - 3/8" M SOCKET ADAPTER

1/2" F - 3/8" M **LOKMA ADAPTÖR**



3/8" - 1/4" BIT ADAPTER

3/8" - 1/4" **BITS ADAPTÖR**



KOD	ÜRÜN	10	200	FİYAT
007-RC7422	1/2" F-3/8"	10	200	4,10 \$

KOD	ÜRÜN	10	200	FİYAT
007-RC7415	3/8" - 1/4"	10	200	3,80 \$

1/2" F - 3/4" M SOCKET ADAPTER

1/2" F - 3/4" M **LOKMA ADAPTÖR**



3/8" - 3/8" BIT ADAPTER

3/8" - 3/8" **BITS ADAPTÖR**



KOD	ÜRÜN	10	150	FİYAT
007-RC7420	1/2" F-3/4"	10	150	7,25 \$

KOD	ÜRÜN	10	200	FİYAT
007-RC7417	3/8" - 3/8"	10	200	4,00 \$

1/4" F - 3/8" M ADAPTER

1/4" F - 3/8" M **ADAPTÖR**



1/2" - 3/8" BIT ADAPTER

1/2" - 3/8" **BITS ADAPTÖR**



KOD	ÜRÜN	10	400	FİYAT
007-RC7412	1/4" F-3/8"	10	400	2,60 \$

KOD	ÜRÜN	10	200	FİYAT
007-RC7416	1/2" - 3/8"	10	200	4,10 \$

UNIVERSAL JOINT

OYNAR MAFSAL



KOD	ÜRÜN	3D	2D	FİYAT
007-RC3005	1/4" Oynar Mafsal	10	200	3,50 \$
007-RC3004	3/8" Oynar Mafsal	10	200	4,75 \$
007-RC3003	1/2" Oynar Mafsal	5	400	6,85 \$

1/2" M TYPE S. 100MM TAMPER

1/2" M TİPİ LOKMA 100MM DELİKLİ



KOD	ÜRÜN	3D	2D	FİYAT
007-RC5716	16 mm	10	60	7,25 \$

ÜRÜN ÖZELLİKLERİ

Yüksek Kaliteli CRV çeliğinden Üretilmiştir.
Bits Uçlar S2 Çeliğinden Üretilmiştir
Parlak Krom Kaplama
Polisajlanmış Yüzeyler



1/2" ALTERNATOR SOCKET M10

1/2" ALTERNATÖR LOKMA M10



KOD	ÜRÜN	3D	2D	FİYAT
007-RC9807	1/2" M10 Alternatör Lokma	20	200	10,00 \$

1/2" ALTERNATOR SOCKET T50

1/2" ALTERNATÖR LOKMA T50



KOD	ÜRÜN	3D	2D	FİYAT
007-RC9806	1/2" T50 Alternatör Lokma	20	200	10,00 \$

3/8" SPARK PLUG SOCKET

3/8" BUJİ LOKMA 14MM 12 KÖŞE



KOD	ÜRÜN	3D	2D	FİYAT
007-RC2997	3/8" Buji Lokma 14mm 9cm	10	180	9,10 \$
007-RC2998	3/8" Buji Lokma 14mm 25cm	5	60	20,80 \$

1/4" SPINNER HANDLE

1/4" LOKMA TUTUCU ADAPTÖR



KOD	ÜRÜN	3D	2D	FİYAT
007-RC3006	1/4" Lokma Tutucu Adaptör Kısa	10	200	3,30 \$
020-RC9922	1/4" Lokma Tutucu Adaptör Uzun	5	40	3,75 \$

1/4" EXTENSION BAR

1/4" **UZATMA**



KOD	ÜRÜN	📦	📦	FİYAT
007-RC7050	50mm	40	400	1,35 \$
007-RC7075	75mm	30	300	1,58 \$
007-RC7100	100mm	20	200	2,15 \$
007-RC7150	150mm	20	200	2,54 \$



1/4" WOBBLE EXTENSION BAR

1/4" **MAFSALLI UZATMA**



KOD	ÜRÜN	📦	📦	FİYAT
007-RC3030	50 mm	20	600	1,48 \$
007-RC3031	75 mm	20	400	1,85 \$
007-RC3032	100 mm	20	400	2,36 \$
007-RC3033	150 mm	20	240	2,87 \$



3/8" EXTENSION BAR

3/8" **UZATMA**



KOD	ÜRÜN	📦	📦	FİYAT
007-RC3875	75 mm	10	60	2,15 \$
007-RC3050	100 mm	10	60	2,20 \$
007-RC3150	150 mm	10	40	4,30 \$
007-RC3250	250 mm	10	40	6,25 \$



3/4" EXTENSION BAR

3/4" **UZATMA**



KOD	ÜRÜN	📦	📦	FİYAT
007-RC34100	100mm	10	40	9,70 \$
007-RC34200	200mm	5	25	17,00 \$
007-RC34400	400mm	3	12	23,00 \$



1/2" EXTENSION BAR

1/2" **UZATMA**



KOD	ÜRÜN	📦	📦	FİYAT
007-RC5150	50 mm	15	120	3,30 \$
007-RC5075	75 mm	15	120	3,75 \$
007-RC5125	125 mm	5	80	5,10 \$
007-RC5250	250 mm	5	40	8,25 \$
007-RC5300	300 mm	5	20	10,35 \$
007-RC5500	500 mm	5	20	18,00 \$



1/2" WOBBLE EXTENSION BAR

1/2" **MAFSALLI UZATMA**



KOD	ÜRÜN	📦	📦	FİYAT
007-RC5050	50 mm	12	120	3,30 \$
007-RC3034	75 mm	10	100	3,80 \$
007-RC3035	125 mm	10	100	5,10 \$
007-RC3036	250 mm	6	48	7,90 \$
007-RC3037	300 mm	6	36	9,80 \$



1/2" T BAR WITH SOCKET

1/2" T MAFSALLI LOKMA



KOD	ÜRÜN	📦	📦	FİYAT
007-RC4207	7 mm	5	40	18,50 \$
007-RC4208	8 mm	5	40	18,50 \$
007-RC4210	10 mm	5	60	19,00 \$
007-RC4211	11 mm	5	60	19,50 \$
007-RC4212	12 mm	5	40	20,00 \$
007-RC4213	13 mm	5	30	20,50 \$
007-RC4214	14 mm	5	30	22,00 \$
007-RC4215	15 mm	5	30	22,00 \$
007-RC4216	16 mm	5	30	22,00 \$
007-RC4217	17 mm	5	30	22,50 \$
007-RC4219	19 mm	5	20	23,00 \$
007-RC5116	16 mm Buji	5	20	23,00 \$

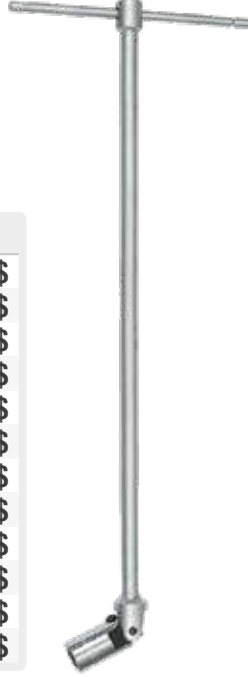

T BAR WITH ADAPTER

T MAFSALLI ADAPTÖR



KOD	ÜRÜN	📦	📦	FİYAT
007-RC3023	1/4"	10	60	23,00 \$
007-RC3027	3/8"	5	20	24,00 \$
007-RC3026	1/2"	5	20	25,00 \$

ÜRÜN ÖZELLİKLERİ

Yüksek Kaliteli CRV çeliğinden Üretilmiştir.
Parlak Krom Kaplama, Polisajlanmış Yüzeyler

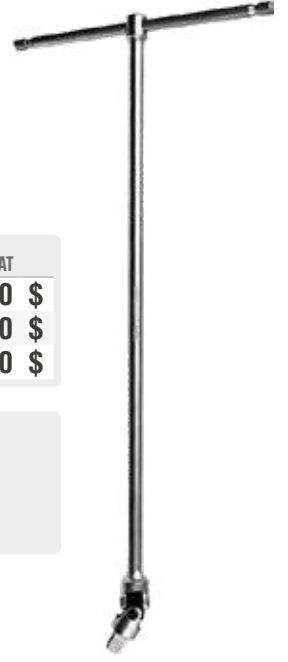

T SOCKET 8-10-13mm

ÜÇLÜ T LOKMA



KOD	ÜRÜN	📦	📦	FİYAT
007-RC6681	8-10-13mm	5	50	7,00 \$

ÜRÜN ÖZELLİKLERİ

Yüksek Kaliteli CRV çeliğinden Üretilmiştir.
Parlak Krom Kaplama, Polisajlanmış Yüzeyler



T SOCKET

T LOKMA



KOD	ÜRÜN	📦	📦	FİYAT
007-RC6675	8 mm	35	70	8,00 \$
007-RC6676	10 mm	8	64	8,10 \$
007-RC6677	11 mm	35	70	8,20 \$
007-RC6678	12 mm	35	70	8,30 \$
007-RC6679	13 mm	10	60	8,40 \$
007-RC6680	14 mm	10	60	8,50 \$



1/4" FLEXIBLE EXTENSION BAR

1/4" FLEX UZATMA



Made in
Türkiye

KOD	ÜRÜN	📦	📦	FİYAT
007-RC7234	150mm	10	200	3,20 \$
007-RC7235	250mm	10	200	4,60 \$



1/4" EXTENSION BAR 19-32MM MAGNETIC

SUSTALI Mıknatıslı Adaptör

1/4" EXTENSION BAR 19-32 MM

SUSTALI Uzatma Açılı Uç

KOD	ÜRÜN	6	72	FİYAT
007-RC7401	1/4" Torn. Adaptör Sustalı Mıkn.	6	72	8,00 \$

KOD	ÜRÜN	6	72	FİYAT
007-RC7300	1/4" Sustalı Uzatma Açılı Uç	6	72	6,00 \$

1/4" EXTENSION BAR 19-32MM MAGNETIC

SUSTALI Uzatma Mıknatıslı

1/2" EXTENSION BAR 25-40MM MAG.

SUSTALI Uzatma Mıknatıslı

KOD	ÜRÜN	6	72	FİYAT
007-RC7200	1/4" Sustalı Uzatma Mıknatıslı	6	72	7,00 \$

KOD	ÜRÜN	6	72	FİYAT
007-RC6101	1/2" Sustalı Uzatma Mıknatıslı	6	72	14,00 \$

DIGITAL ADJUSTABLE RATCHETING HEAD TORQUE WRENCH

DİJİTAL CİRCİRLİ TORK KOL ANAHTARI

KOD	ÜRÜN	📦	📦	FİYAT
007-RC1630	1/4 Tork Kol 1,5-30 N.M	1	10	177,00 \$

ADJUSTABLE RATCHETING HEAD TORQUE WRENCH

CİRCİRLİ TORK KOL ANAHTARI

KOD	ÜRÜN	📦	📦	FİYAT
007-RC1631	1/4 Tork Kol 0,5-2,6 KGF.M	1	10	100,00 \$
007-RC1632	1/2 Tork Kol 5-23 KGF.M	1	10	160,00 \$
007-RC1633	1/2 Tork Kol 3-14 KGF.M	1	10	140,00 \$

ADJUSTABLE NON-RATCHETING HEAD TORQUE WRENCH

TORK KOLU GTW

KOD	ÜRÜN	📦	📦	FİYAT
007-RC1617	Tork Kol GTW 100 3-14 KGS	1	10	172,00 \$
007-RC1613	Tork Kol GTW 160 5-23 KGS	1	10	188,00 \$
007-RC1614	Tork Kol GTW 250 7-35 KGS	1	10	210,00 \$

1" T BAR
1" AĞIR T KOL



KOD	ÜRÜN	📦	📦	FİYAT
007-RC34500	1" T Kol	1	6	60,00 \$

3/4" T BAR
3/4" T KOL



KOD	ÜRÜN	📦	📦	FİYAT
007-RC34450	3/4" T Kol	2	10	29,00 \$

1/2" L BAR
1/2" L KOL



KOD	ÜRÜN	📦	📦	FİYAT
020-RC9923	1/2" L Kol	8	32	10,00 \$

3/4" L BAR
3/4" L KOL



KOD	ÜRÜN	📦	📦	FİYAT
007-RC34451	3/4" L Kol	8	32	24,00 \$

T BAR
T KOL

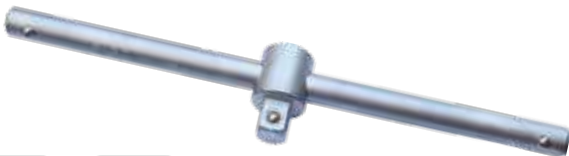

KOD	ÜRÜN	📦	📦	FİYAT
007-RC2999	1/4" 100mm	15	300	3,00 \$
007-RC3000	3/8" 200mm	10	100	5,20 \$
007-RC3001	1/2" 250mm	6	36	9,50 \$
001-RC3002	1/2" 300mm	5	20	10,00 \$
001-RC3003	1/2" 350mm	5	20	12,00 \$



1/2" 6 PT DEEP AIR IMPACT SOCKET

1/2" 6 KÖŞE DERİN HAVALI LOKMA



KOD	ÜRÜN	📦	📦	FİYAT
022-RC2310	10 mm	10	100	5,55 \$
022-RC2311	11 mm	10	100	5,66 \$
022-RC2312	12 mm	10	100	5,77 \$
022-RC2313	13 mm	10	100	5,88 \$
022-RC2314	14 mm	10	100	6,00 \$
022-RC2315	15 mm	10	100	6,07 \$
022-RC2316	16 mm	10	100	6,21 \$
022-RC2317	17 mm	10	80	6,32 \$
022-RC2318	18 mm	10	100	6,43 \$
022-RC2319	19 mm	10	80	6,60 \$
022-RC2321	21 mm	10	80	7,04 \$
022-RC2322	22 mm	10	60	7,45 \$
022-RC2324	24 mm	10	60	8,40 \$
022-RC2327	27 mm	10	60	11,05 \$
022-RC2330	30 mm	10	60	12,00 \$
022-RC2332	32 mm	10	60	14,55 \$



1/2" 6 PT AIR IMPACT SOCKET SHORT

1/2" 6 KÖŞE KISA HAVALI LOKMA



KOD	ÜRÜN	📦	📦	FİYAT
022-RC2210	10 mm	10	200	2,70 \$
022-RC2211	11 mm	10	200	2,75 \$
022-RC2212	12 mm	10	200	2,80 \$
022-RC2213	13 mm	10	200	2,86 \$
022-RC2214	14 mm	10	200	2,91 \$
022-RC2215	15 mm	10	200	3,00 \$
022-RC2216	16 mm	10	200	3,15 \$
022-RC2217	17 mm	25	200	3,26 \$
022-RC2218	18 mm	10	200	3,38 \$
022-RC2219	19 mm	20	200	3,50 \$
022-RC2221	21 mm	15	60	3,75 \$
022-RC2222	22 mm	15	60	3,87 \$
022-RC2224	24 mm	10	100	4,55 \$
022-RC2227	27 mm	10	100	5,83 \$
022-RC2230	30 mm	15	60	7,08 \$
022-RC2232	32 mm	15	60	7,70 \$



3/4" 6 PT DEEP AIR IMPACT SOCKET

3/4" 6 KÖŞE DERİN HAVALI LOKMALAR



KOD	ÜRÜN	📦	📦	FİYAT
022-RC2817	17 mm	10	30	14,60 \$
022-RC2819	19 mm	10	30	15,60 \$
022-RC2824	24 mm	10	30	17,60 \$
022-RC2827	27 mm	10	30	18,20 \$
022-RC2830	30 mm	10	30	19,00 \$
022-RC2832	32 mm	10	30	20,00 \$
022-RC2836	36 mm	10	30	22,00 \$
022-RC2841	41 mm	8	24	25,00 \$



3/4" 6 PT AIR IMPACT SOCKET SHORT

3/4" 6 KÖŞE KISA HAVALI LOKMA



KOD	ÜRÜN	📦	📦	FİYAT
022-RC2417	17 mm	15	60	9,50 \$
022-RC2419	19 mm	15	60	9,70 \$
022-RC2424	24 mm	15	60	11,00 \$
022-RC2427	27 mm	15	30	11,60 \$
022-RC2430	30 mm	15	30	12,10 \$
022-RC2432	32 mm	8	32	13,70 \$
022-RC2434	34 mm	8	32	15,40 \$
022-RC2436	36 mm	8	32	17,00 \$
022-RC2438	38 mm	8	32	17,60 \$
022-RC2441	41 mm	8	16	19,30 \$
022-RC2446	46 mm	8	16	22,00 \$
022-RC2450	50 mm	5	16	26,40 \$
022-RC2455	55 mm	5	16	31,90 \$
022-RC2460	60 mm	5	10	36,00 \$
022-RC2465	65 mm	5	10	44,00 \$
022-RC2470	70 mm	5	10	49,50 \$



1" 6 PT AIR IMPACT SOCKET SHORT

1" 6 KÖŞE KISA HAVALI LOKMA



KOD	ÜRÜN	📦	📦	FİYAT
022-RC2627	27 mm	10	16	17,15 \$
022-RC2628	28 mm	10	16	17,60 \$
022-RC2630	30 mm	10	10	18,15 \$
022-RC2632	32 mm	10	10	18,35 \$
022-RC2633	33 mm	10	10	20,70 \$
022-RC2636	36 mm	10	16	20,90 \$
022-RC2638	38 mm	10	16	21,45 \$
022-RC2641	41 mm	8	16	22,00 \$
022-RC2646	46 mm	8	16	27,30 \$
022-RC2655	55 mm	4	8	40,70 \$
022-RC2660	60 mm	4	8	46,85 \$
022-RC2665	65 mm	4	8	60,00 \$
022-RC2670	70 mm	2	4	75,00 \$
022-RC2675	75 mm	2	4	110,00 \$
022-RC2680	80 mm	2	4	120,00 \$
022-RC2685	85 mm	2	3	130,00 \$



1" 6 PT DEEP AIR IMPACT SOCKET

1" 6 KÖŞE DERİN HAVALI LOKMALAR



KOD	ÜRÜN	📦	📦	FİYAT
022-RC2727	27mm	10	16	27,50 \$
022-RC2728	28mm	10	16	28,00 \$
022-RC2730	30mm	10	16	29,15 \$
022-RC2732	32mm	10	16	30,80 \$
022-RC2733	33mm	10	16	33,00 \$
022-RC2736	36mm	10	16	35,00 \$
022-RC2738	38mm	10	16	36,00 \$
022-RC2741	41 mm	8	12	38,00 \$
022-RC2746	46mm	8	12	41,25 \$
022-RC2765	65mm	5	10	89,40 \$



3/4"-1/2" IMPACT ADAPTOR
3/4"-1/2" DEĞİŞEBİLİR
HAVALI ADAPTÖR



KOD	ÜRÜN	📦	📦	FİYAT
022-RC4115	3/4"-1/2"	10	100	19,00 \$

3/4"-1/2" IMPACT ADAPTOR
3/4"-1/2" DEĞİŞEBİLİR
HAVALI UÇ



KOD	ÜRÜN	📦	📦	FİYAT
022-RC4116	3/4"-1/2"	10	100	5,25 \$

1/2" - 3/4" IMPACT ADAPTOR
1/2"-3/4" HAVALI
ADAPTÖR



KOD	ÜRÜN	📦	📦	FİYAT
022-RC4089	1/2"-3/4"	10	100	8,75 \$

1" - 3/4" IMPACT ADAPTOR
3/4" - 1/2" IMPACT ADAPTOR
HAVALI ADAPTÖR



KOD	ÜRÜN	📦	📦	FİYAT
022-RC4094	1"-3/4"	8	16	24,50 \$
022-RC4095	3/4"-1/2"	10	40	15,50 \$

3/4" 12 PT IMPACT SOCKET
3/4" 12 KÖŞE HAVALI LOKMA



KOD	ÜRÜN	📦	📦	FİYAT
022-RC2536	36 mm	8	32	17,00 \$
022-RC2541	41 mm	8	32	19,30 \$
022-RC2546	46 mm	8	16	22,15 \$
022-RC2565	65 mm	5	10	44,55 \$

1/2" IMPACT UNIVERSAL JOINT BALL TYPE
1/2" HAVALI MAFSAL



KOD	ÜRÜN	📦	📦	FİYAT
022-RC2842	1/2"	10	60	11,00 \$

3/4" IMPACT UNIVERSAL JOINT
3/4" HAVALI MAFSAL



KOD	ÜRÜN	📦	📦	FİYAT
022-RC2843	3/4"	10	30	33,00 \$

1" IMPACT EXTENSION BAR
1" HAVALI UZATMA



KOD	ÜRÜN	📦	📦	FİYAT
022-RC27150	150 mm	5	20	29,00 \$
022-RC27200	200 mm	5	20	33,00 \$

3/4" IMPACT EXTENSION BAR
3/4" HAVALI UZATMA



KOD	ÜRÜN	📦	📦	FİYAT
022-RC22100	100 mm	10	60	17,50 \$
022-RC22150	150 mm	10	20	19,50 \$
022-RC22200	200 mm	5	20	21,50 \$

1/2" IMPACT EXTENSION BAR
1/2" HAVALI UZATMA



KOD	ÜRÜN	📦	📦	FİYAT
022-RC2075	75 mm	20	60	6,00 \$
022-RC2125	125 mm	10	40	7,30 \$

PROFESYONEL ÇÖZÜM ORTAĞINIZ

RICO[®] PROFESSIONAL

CIRCIR KOLLARI

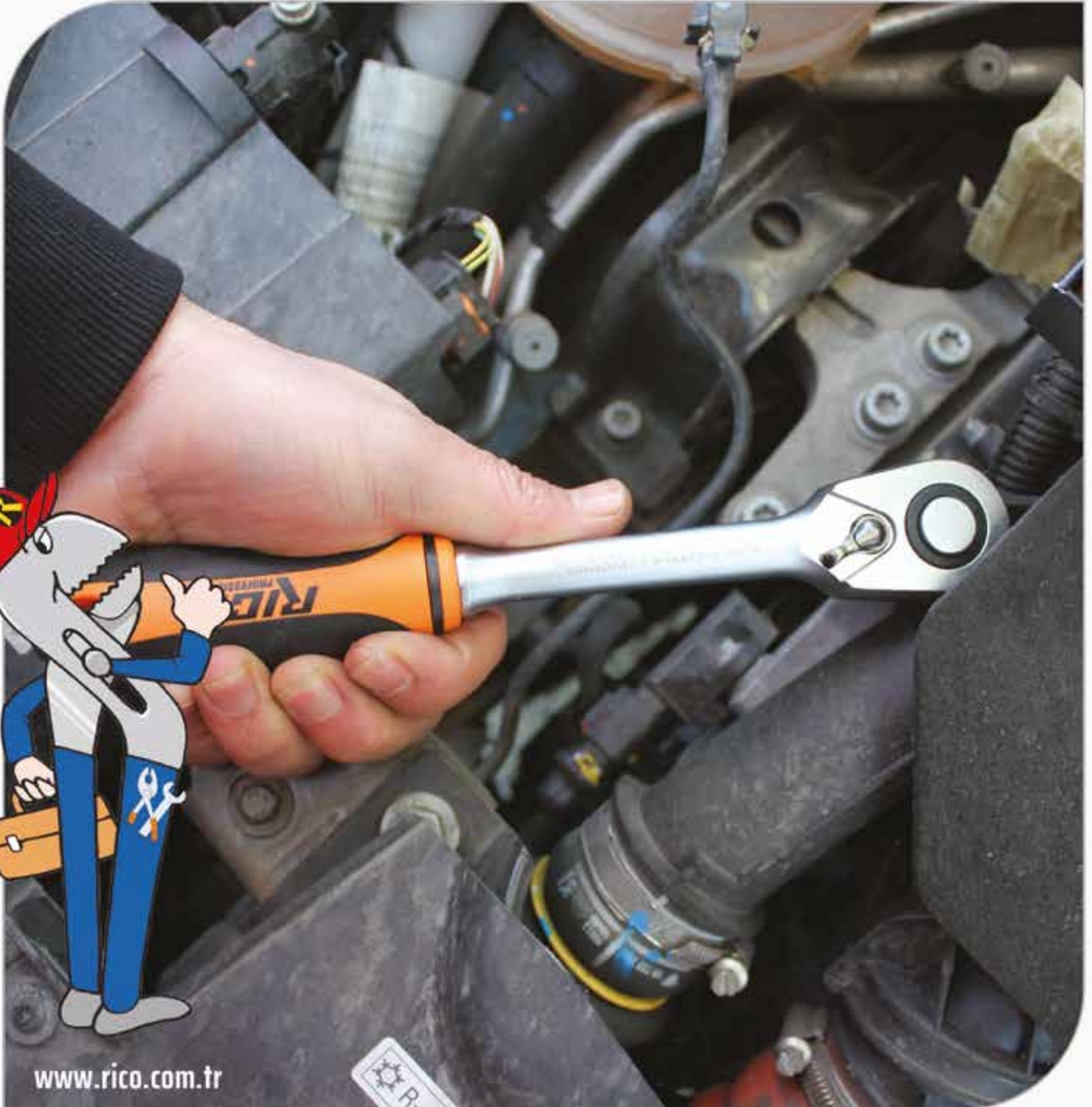

www.rico.com.tr



72 TEETH EXTENDABLE RATCHET HANDLE

CIRCIR KOLU UZATMALI 72 DİŞ



KOD	ÜRÜN	📦	📦	FİYAT
007-KK1472	1/4"	12	72	19,00 \$
007-KK3872	3/8"	12	48	25,00 \$
007-KK1272	1/2"	10	20	34,00 \$

48 TEETH SCREW TYPE RATCHET HANDLE

CIRCIR KOLU VİDALI TİP 48 DİŞ



KOD	ÜRÜN	📦	📦	FİYAT
007-RC3315	1/4"	12	96	15,75 \$
007-RC3316	3/8"	12	72	21,00 \$
007-RC3317	1/2"	6	36	27,00 \$

48 TEETH C-RING TYPE RATCHET HANDLE

CIRCIR KOLU SEKMAN TİP 48 DİŞ



KOD	ÜRÜN	📦	📦	FİYAT
007-RC3314	1/4"	12	24	15,75 \$
007-RC3313	3/8"	12	100	21,00 \$
007-RC3312	1/2"	6	24	27,00 \$
007-RC3318	1/2"	6	36	27,00 \$

72 TEETH RATCHET HANDLE

CIRCIR KOLU 72 DİŞ



KOD	ÜRÜN	📦	📦	FİYAT
007-RC2008	1/4"	25	100	15,75 \$

72 TEETH RATCHET HANDLE

1/2" CIRCIR KOLU 72 DİŞ



KOD	ÜRÜN	📦	📦	FİYAT
007-RC1472	1/4"	10	100	14,75 \$
007-RC1272	1/2"	6	60	27,00 \$

3/4" RATCHET HANDLE

3/4" AĞIR CIRCIR KOLU



KOD	ÜRÜN	📦	📦	FİYAT
006-RC1023	3/4"	2	10	80,36 \$

TWO FUNCTION MINI RATCHET 60 TEETH

1/4" 2 FONKSİYONLU MİNİ CİRCİR 60 DİŞ

KOD	ÜRÜN	3D	2D	FİYAT
007-RC2000	1/4" Mini Cırcır Kolu 60 Diş	25	100	14,00 \$

TWO FUNCTION MINI RATCHET FOR BITS 60 TEETH

1/4" 2 FONKSİYONLU MİNİ BİTS CİRCİR 60 DİŞ

KOD	ÜRÜN	3D	2D	FİYAT
007-RC2001	1/4" Mini Bits Cırcır Kolu 60 Diş	25	100	14,00 \$

MINI RATCHET FOR SOCKET 72 TEETH

1/4" CİRCİR KOLU 72 DİŞ

KOD	ÜRÜN	3D	2D	FİYAT
007-RC2002	1/4" Mini Cırcır Kolu 72 Diş	25	100	14,00 \$

TWO WAY MINI RATCHET FOR SOCKET BITS 72 TEETH

1/4" 2 FONKSİYONLU MİNİ CİRCİR 72 DİŞ

KOD	ÜRÜN	3D	2D	FİYAT
007-RC2004	1/4" Mini Bits & Cırcır Kolu 72 Diş	25	100	14,85 \$

MINI RATCHET FOR BITS 72 TEETH

1/4" MİNİ BİTS CİRCİR KOLU 72 DİŞ

KOD	ÜRÜN	3D	2D	FİYAT
007-RC2003	1/4" Mini Bits Cırcır Kolu 72 Diş	25	100	14,85 \$

TWO WAY MINI RATCHET FOR SOCKET BITS 72 TEETH

1/4" 2 FONKSİYONLU MİNİ CİRCİR

**PROFESYONEL
ÇÖZÜM ORTAĞINIZ**

RICO[®]
PROFESSIONAL

ANAHTAR GRUPLARI

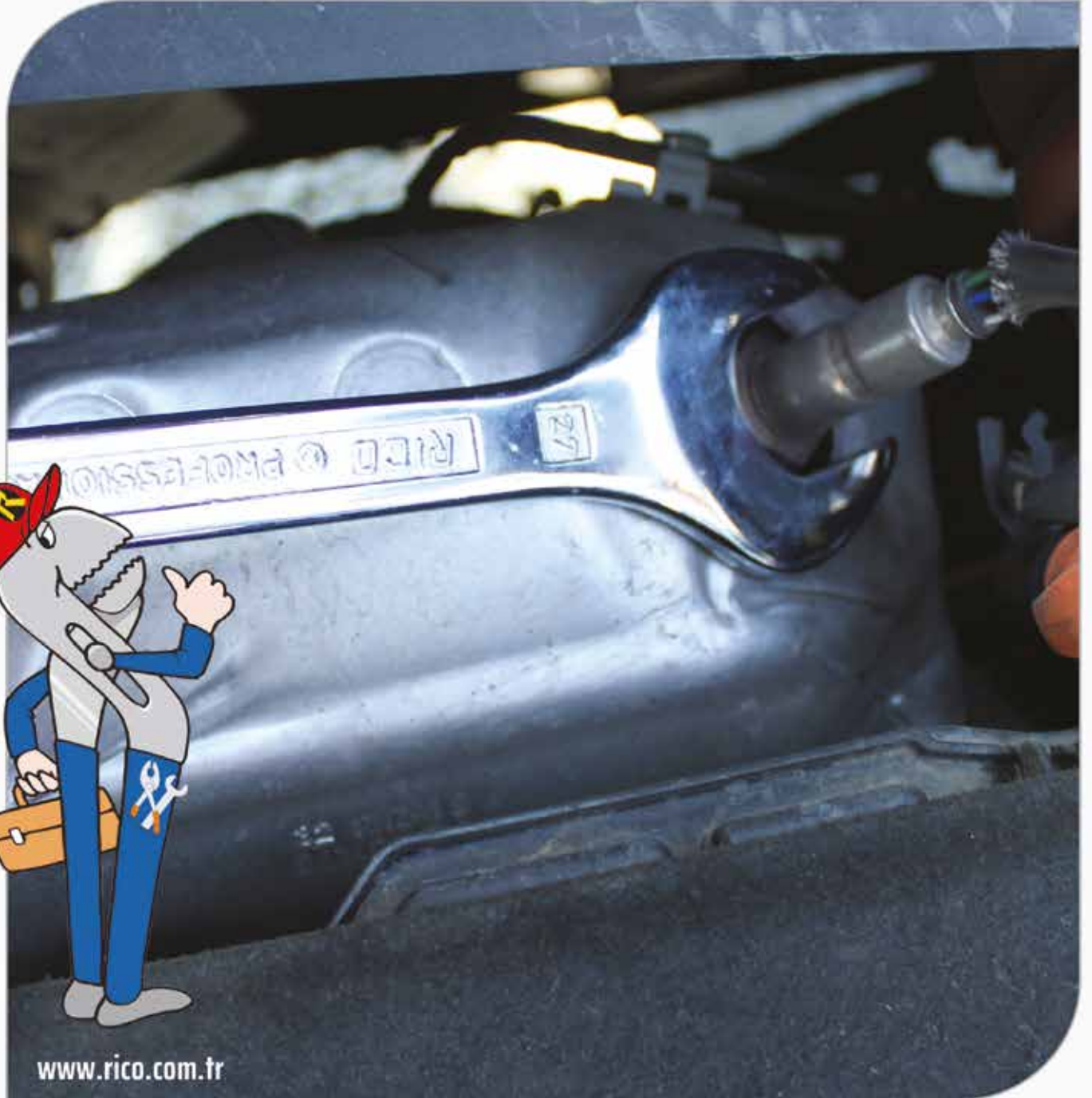

www.rico.com.tr

EXTRA DOUBLE OPEN END SPANNER

EKSTRA İKİ AĞIZ **KISA ANAHTAR**



KOD	ÜRÜN	📦	📦	FİYAT
020-RC8067	6x7	10	400	1,15 \$
020-RC8089	8x9	10	400	1,50 \$
020-RC801011	10x11	10	400	1,85 \$
020-RC801213	12x13	10	400	2,25 \$
020-RC801415	14x15	10	250	2,55 \$
020-RC801617	16x17	10	200	3,00 \$
020-RC801819	18x19	10	150	3,50 \$
020-RC802022	20x22	10	100	4,20 \$
020-RC802123	21x23	10	100	4,85 \$
020-RC802427	24x27	10	80	6,55 \$
020-RC802528	25x28	10	60	6,85 \$
020-RC803032	30x32	10	40	8,20 \$
020-RC803641	36x41	5	20	29,00 \$
020-RC804146	41x46	3	12	38,00 \$
020-RC804650	46x50	2	12	48,00 \$



EXTRA COMBINATION SPANNER

EKSTRA KOMBİNE **ANAHTAR**



KOD	ÜRÜN	📦	📦	FİYAT
020-RC9060	6	10	500	1,65 \$
020-RC9070	7	10	500	1,78 \$
020-RC9080	8	10	400	2,00 \$
020-RC9090	9	10	200	2,20 \$
020-RC9100	10	10	200	2,55 \$
020-RC9110	11	10	203	2,60 \$
020-RC9120	12	10	200	2,75 \$
020-RC9130	13	10	200	3,15 \$
020-RC9140	14	10	200	3,40 \$
020-RC9150	15	10	200	3,80 \$
020-RC9160	16	10	200	4,30 \$
020-RC9170	17	10	150	4,60 \$
020-RC9180	18	10	120	5,20 \$
020-RC9190	19	10	120	5,50 \$
020-RC9200	20	10	120	5,95 \$
020-RC9210	21	10	120	6,75 \$
020-RC9220	22	10	80	7,40 \$
020-RC9683	23	10	80	8,40 \$
020-RC9240	24	10	80	8,55 \$
020-RC9270	27	10	60	12,00 \$
020-RC9300	30	10	40	15,30 \$
020-RC9320	32	10	40	18,20 \$
020-RC9360	36	5	20	25,75 \$



EXTRA DOUBLE OPEN END SPANNERS SET

EKSTRA DÜZ KISA **ANAHTAR SETİ**



KOD	ÜRÜN	📦	📦	FİYAT
020-RC8006	6PC Ekstra Düz Kısa Anahtar Seti	6	48	12,00 \$
020-RC8008	8PC Ekstra Düz Kısa Anahtar Seti	4	24	19,00 \$
020-RC8012	12PC Ekstra Düz Kısa Anahtar Seti	2	12	42,00 \$

ÜRÜN ÖZELLİKLERİ

6 PC: 6x7, 8x9, 10x11, 12x13, 14x15, 16x17

8 PC: 6x7, 8x9, 10x11, 12x13, 14x15, 16x17, 18x19, 20x22

12 PC: 6x7, 8x9, 10x11, 12x13, 14x15, 16x17, 18x19, 20x22, 21x23, 24x27, 25x28, 30x32

EXTRA COMBINATION SPANNER SET

EKSTRA KOMBİNE **ANAHTAR SETİ**



KOD	ÜRÜN	📦	📦	FİYAT
020-RC9608	8PC Ekstra Kombine Anahtar Seti	4	32	24,65 \$
020-RC9612	12PC Ekstra Kombine Anahtar Seti	2	18	35,20 \$
020-RC9621	21 PC Ekstra Kombine Anahtar Seti	1	5	108,00 \$

ÜRÜN ÖZELLİKLERİ

8 PC: 8, 9, 10, 11, 13, 17, 19, 21

12 PC: 6, 7, 8, 9, 10, 11, 12, 13, 14, 17, 19, 22

21 PC: 6, 7, 8, 9, 10, 11, 12, 13, 14, 15, 16, 17, 18, 19, 20, 21, 22, 24, 27, 30, 32

EXTRA BIHEXAGONAL SPANNER
EKSTRA YILDIZ ANAHTAR

KOD	ÜRÜN	📦	📦	FİYAT
020-RC7067	6x7	10	500	2,76 \$
020-RC7089	8x9	10	500	3,56 \$
020-RC701011	10x11	10	200	4,00 \$
020-RC701213	12x13	10	200	4,70 \$
020-RC701415	14x15	10	100	4,95 \$
020-RC701617	16x17	10	100	6,00 \$
020-RC701819	18x19	10	80	7,25 \$
020-RC702022	20x22	10	80	8,47 \$
020-RC702123	21x23	10	60	9,36 \$
020-RC702427	24x27	10	60	11,73 \$
020-RC702528	25x28	10	40	12,10 \$
020-RC703032	30x32	10	40	14,35 \$
020-RC703641	36x41	5	20	31,51 \$

EXTRA BIHEXAGONAL SPANNER SET
EKSTRA YILDIZ ANAHTAR SETİ

KOD	ÜRÜN	📦	📦	FİYAT
020-KK5106	6PC Yıldız Anahtar Seti	4	24	29,70 \$
020-RC7008	8PC Ekstra Yıldız Anahtar Seti	4	16	34,75 \$
020-RC7012	12PC Ekstra Yıldız Anahtar Seti	2	8	85,00 \$

ÜRÜN ÖZELLİKLERİ
6 PC: 6x7, 8x9, 10x11, 12x13, 14x15, 16x17

8 PC: 6x7, 8x9, 10x11, 12x13, 14x15, 16x17, 18x19, 20x22

12 PC: 6x7, 8x9, 10x11, 12x13, 14x15, 16x17, 18x19, 20x22, 21x23, 24x27, 25x28, 30x32

BIHEXAGONAL STRAIGHT SPANNER
DÜZ YILDIZ ANAHTAR

KOD	ÜRÜN	📦	📦	FİYAT
020-RC1034127	6x7	10	400	1,47 \$
020-RC1034128	8x9	10	300	1,71 \$
020-RC1034129	10x11	10	200	1,86 \$
020-RC1034130	12x13	10	200	2,05 \$
020-RC1034131	14x15	10	120	2,35 \$
020-RC1034132	16x17	10	120	2,80 \$
020-RC1034133	18x19	10	80	3,57 \$
020-RC1034134	20x22	10	80	3,92 \$
020-RC1034135	21x23	10	80	5,68 \$
020-RC1034136	24x26	10	60	6,72 \$
020-RC1034138	25x28	10	60	8,00 \$
020-RC1034139	27x32	5	40	9,20 \$

DOUBLE OPEN END LONG SPANNER
UZUN İKİ AĞIZ ANAHTAR

KOD	ÜRÜN	📦	📦	FİYAT
020-RC5701	6x7	10	500	1,60 \$
020-RC5702	8x9	10	500	1,80 \$
020-RC5703	10x11	10	400	2,20 \$
020-RC5704	12x13	10	400	2,50 \$
020-RC5705	14x15	10	250	3,15 \$
020-RC5706	16x17	10	200	3,85 \$
020-RC5707	18x19	10	150	4,70 \$
020-RC5708	20x22	10	100	5,25 \$
020-RC5713	21x23	10	100	5,50 \$
020-RC5709	24x27	10	80	7,25 \$
020-RC5710	25x28	10	60	7,80 \$
020-RC5711	30x32	10	40	9,25 \$



FLARE NUT WRENCH

REKOR **ANAHTAR**



KOD	ÜRÜN	📦	📦	FİYAT
020-RC0810	8x10 mm	10	200	3,60 \$
020-RC1011	10x11 mm	10	200	3,95 \$
020-RC1112	10x12 mm	10	200	4,32 \$
020-RC1113	11x13 mm	10	200	4,70 \$
020-RC1214	12x14 mm	10	200	5,00 \$
020-RC1617	16x17 mm	10	100	5,50 \$
020-RC1618	16x18 mm	10	100	5,65 \$
020-RC1719	17x19 mm	10	100	6,15 \$



E-TYPE SPANNER

E-**ANAHTAR**



KOD	ÜRÜN	📦	📦	FİYAT
020-RC8773	E6xE8	10	200	1,44 \$
020-RC8775	E10xE12	10	200	1,70 \$
020-RC8776	E14xE16	10	200	2,20 \$
020-RC8777	E18xE20	10	150	2,90 \$
020-RC8778	E22xE24	10	120	3,45 \$



DOUBLE ENDED TAMPER TUBULAR SPANNER

KOVAN ANAHTARLARI **DELİKLİ**



Made in
Türkiye

KOD	ÜRÜN	📦	📦	FİYAT
020-RC4708	6x7 mm	12	120	1,80 \$
020-RC4709	8x9 mm	12	120	1,92 \$
020-RC4710	10x11 mm	12	120	2,15 \$
020-RC4711	12x13 mm	12	120	2,39 \$
020-RC4712	14x15 mm	6	36	2,60 \$
020-RC4713	16x17 mm	6	36	3,20 \$



6PCS FLARE NUT WRENCH SET

6PC REKOR **ANAHTAR SETİ**



KOD	ÜRÜN	📦	📦	FİYAT
020-RC2428	6PC Rekor Anahtar Seti	6	24	26,50 \$

ÜRÜN ÖZELLİKLERİ

6 PC: 8x10, 10x11, 10x12, 11x13, 12x14, 17x19

5PCS E SPANNER SET

5PC E **ANAHTAR SETİ**



KOD	ÜRÜN	📦	📦	FİYAT
020-RC8779	5PC E Anahtar Set	4	32	9,60 \$

ÜRÜN ÖZELLİKLERİ

5 PC: E6xE8, E10xE12, E14xE16, E18xE20, E22xE24

6PCS TUBULAR SPANNER SET

6PC KOVAN **ANAHTAR SETİ**
DELİKLİ



Made in
Türkiye



KOD	ÜRÜN	📦	📦	FİYAT
020-RC4714	6PC Kovan Anahtar Set	1	24	14,75 \$

ÜRÜN ÖZELLİKLERİ

6 PC: 6x7, 8x9, 10x11, 12x13, 14x15, 16x17

GEAR WRENCH

DÜZ KONTRA **ANAHTAR**



KOD	ÜRÜN	📦	📦	FİYAT
020-RC1035	8 mm	10	200	5,75 \$
020-RC1036	10 mm	10	200	6,70 \$
020-RC1037	11 mm	10	200	7,60 \$
020-RC1038	12 mm	10	200	7,90 \$
020-RC1039	13 mm	10	100	8,30 \$
020-RC1040	14 mm	10	100	8,60 \$
020-RC1041	15 mm	10	100	10,00 \$
020-RC1042	16 mm	10	100	11,00 \$
020-RC1043	17 mm	10	100	12,20 \$
020-RC1044	18 mm	10	100	13,20 \$
020-RC1045	19 mm	5	50	14,30 \$
020-RC1046	21 mm	5	50	20,30 \$
020-RC1047	22mm	5	50	22,00 \$
020-RC1048	24mm	5	50	24,50 \$



FLEXIBLE GEAR WRENCH

MAFSALLI KONTRA **ANAHTAR**



KOD	ÜRÜN	📦	📦	FİYAT
020-RC1021	8mm	10	200	6,40 \$
020-RC1022	10mm	10	200	7,80 \$
020-RC1023	11mm	10	200	8,80 \$
020-RC1024	12mm	10	200	9,40 \$
020-RC1025	13mm	10	100	10,30 \$
020-RC 1026	14mm	10	100	11,50 \$
020-RC1027	15mm	10	100	12,20 \$
020-RC1028	16mm	10	100	13,20 \$
020-RC1029	17mm	10	100	14,20 \$
020-RC1030	18mm	10	100	15,90 \$
020-RC1031	19mm	5	50	17,60 \$
020-RC1032	21 mm	5	50	23,00 \$
020-RC1033	22mm	5	50	25,30 \$
020-RC1034	24mm	5	50	31,00 \$



GEAR WRENCH

KONTRA **ANAHTAR**



KOD	ÜRÜN	📦	📦	FİYAT
020-RC1008	8 mm	10	216	6,60 \$
020-RC1010	10 mm	10	216	8,40 \$
020-RC1111	11 mm	10	216	9,25 \$
020-RC1012	12 mm	10	216	10,00 \$
020-RC1013	13 mm	10	216	11,00 \$
020-RC1014	14 mm	10	216	11,70 \$
020-RC1015	15 mm	10	180	12,35 \$
020-RC1016	16 mm	10	180	13,35 \$
020-RC 1017	17 mm	10	120	15,65 \$
020-RC1018	18 mm	10	120	16,85 \$
020-RC1019	19 mm	10	120	18,85 \$



8PCS GEAR WRENCH SET

8PC DÜZ KONTRA **ANAHTAR SETİ**

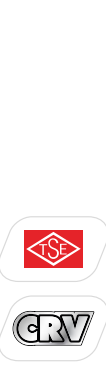

KOD	ÜRÜN	📦	📦	FİYAT
020-RC1049	8PC Düz Kontra Anahtar Seti	2	20	75,00 \$

ÜRÜN ÖZELLİKLERİ

8 PC: 8mm, 10mm, 11mm, 12mm, 13mm, 14mm, 17mm, 19mm

8PCS FLEXIBLE GEAR WRENCH SET

8PC MAFSALLI KONTRA **ANAHTAR SETİ**



KOD	ÜRÜN	📦	📦	FİYAT
020-RC1050	8PC Kontra Anahtar Mafsallı	2	20	88,00 \$

ÜRÜN ÖZELLİKLERİ

8 PC: 8mm, 10mm, 11mm, 12mm, 13mm, 14mm, 17mm, 19mm

HALF MOON SPANNER

YARIM AY **ANAHTAR**



KOD	ÜRÜN	📦	📦	FİYAT
020-RC1315	Yarım Ay Anahtar 13x15 mm	10	200	3,42 \$

**PROFESYONEL
ÇÖZÜM ORTAĞINIZ**

RICO[®]
PROFESSIONAL

PENSE GRUPLARI

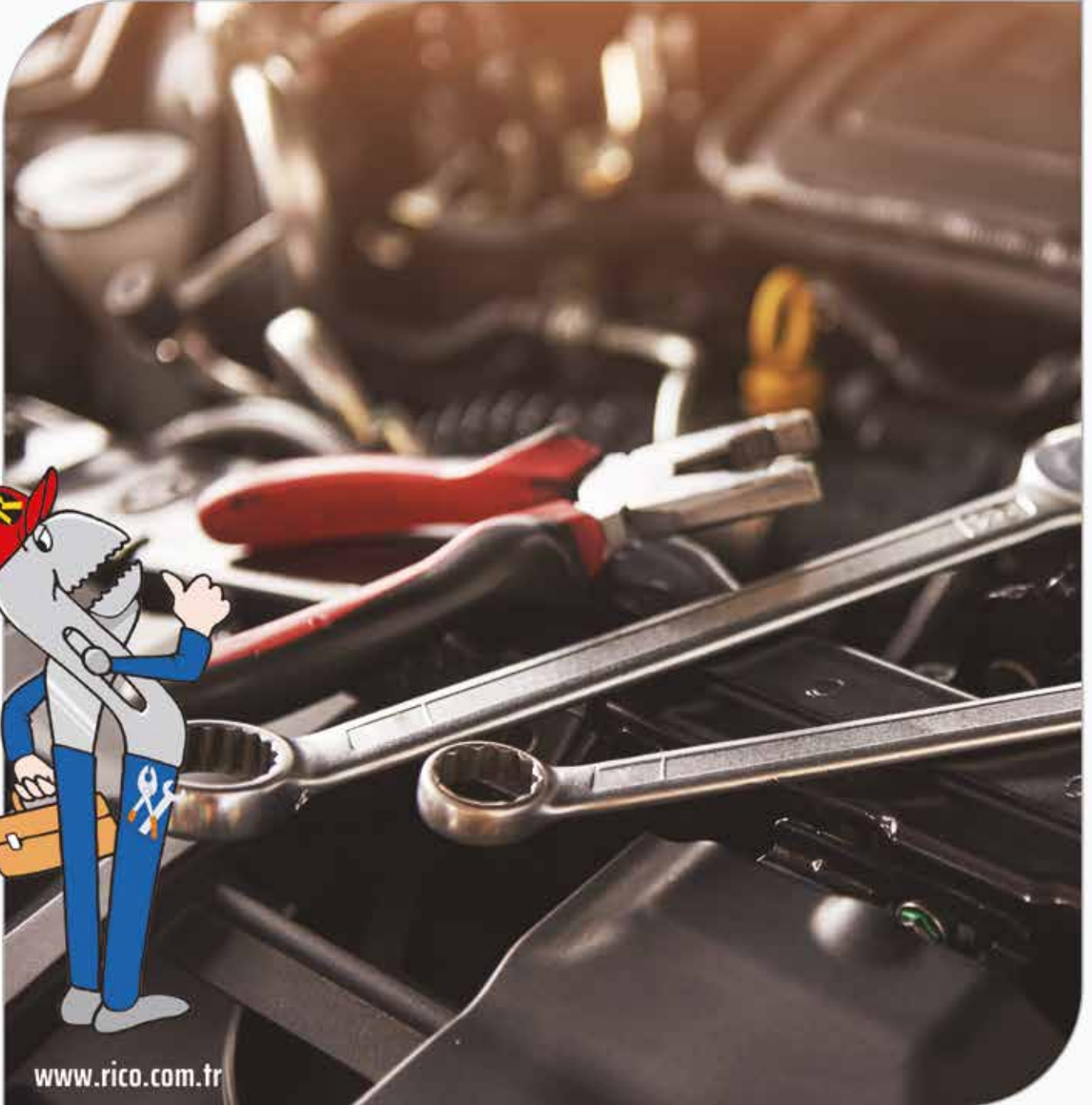

www.rico.com.tr

PROF. COMBINATION PLIER

YENİ TİP PROFESYONEL PENSE

KOD	ÜRÜN	6	60	FİYAT
001-RC0198	6" Prof. Pense	6	60	10,00 \$

PROF. DIAGONAL CUTTER

YENİ TİP PROFESYONEL YANKESKİ

KOD	ÜRÜN	6	60	FİYAT
001-RC0199	6" Prof. Yankeski	6	60	10,00 \$

PROF. COMBINATION PLIER

YENİ TİP PROFESYONEL KARGABURUN

KOD	ÜRÜN	6	60	FİYAT
001-RC0200	6" Prof. Kargaburun	6	60	10,00 \$



COMBINATION PLIER

STEEL PENSE

GRV

KOD	ÜRÜN	📦	📦	FİYAT
001-RC0136	Steel Pense 6"	6	60	9,50 \$
001-RC0137	Steel Pense 7"	6	60	10,50 \$
001-RC0138	Steel Pense 8"	6	60	11,50 \$

COMBINATION DIAGONAL CUTTER

STEEL YANKESKİ

GRV

KOD	ÜRÜN	📦	📦	FİYAT
001-RC0146	Steel Yankeski 6"	6	60	9,50 \$

LONG NOSE PLIER

STEEL KARGABURUN

GRV

KOD	ÜRÜN	📦	📦	FİYAT
001-RC0156	Steel Kargaburun 6"	6	60	9,50 \$

STEEL CURVED NEEDLE-NOSE PLIER

STEEL EĞRİ KARGABURUN

GRV

KOD	ÜRÜN	📦	📦	FİYAT
001-RC0167	Steel Eğri Kargaburun 6"	6	60	9,50 \$

LAYING CLAMP

DÖŞEME PENSESİ

GRV

KOD	ÜRÜN	📦	📦	FİYAT
001-RC0139	Döşeme Pensesi	6	60	9,50 \$

LONG NOSE PLIER ANGULAR

UZUN KARGABURUN

GRV

KOD	ÜRÜN	📦	📦	FİYAT
001-RCU011	Uzun Düz K.Burun 11°	6	60	18,00 \$
001-RCUE20	Uzun Eğri K.Burun 20°	6	60	18,00 \$
001-RCUE45	Uzun Eğri K.Burun 45°	6	60	18,00 \$

PROF. COMBINATION PLIER

PROFESYONEL PENSE



CRAFT COMBINATION PLIER 7"

CRAFT PENSE 7"



Türkiye Made in



DÖVME ÇELİK



KOD	ÜRÜN	6	60	FİYAT
001-RC0190	6" Prof. Pense	6	60	9,50 \$
001-RC0191	7" Prof. Pense	6	60	10,50 \$
001-RC0192	8" Prof. Pense	6	60	11,50 \$

KOD	ÜRÜN	6	60	FİYAT
001-RC0173	7" Craft Pense	6	60	10,00 \$

PROF. DIAGONAL CUTTER

PROFESYONEL YANKESKİ



CRAFT DIAGONAL CUTTER 6"

CRAFT YANKESKİ 6"



Türkiye Made in



DÖVME ÇELİK



KOD	ÜRÜN	6	60	FİYAT
001-RC0195	6" Prof. Yankeski	6	60	9,50 \$
001-RC0144	8" Prof. Yankeski	6	60	11,50 \$

KOD	ÜRÜN	6	60	FİYAT
001-RC0175	6" Craft Yankeski	6	60	9,50 \$

PROF. COMBINATION PLIER

PROFESYONEL KARGABURUN



CRAFT COMBINATION PLIER

CRAFT KARGABURUN 6"



Türkiye Made in



DÖVME ÇELİK



KOD	ÜRÜN	6	60	FİYAT
001-RC0193	6" Prof. Kargaburun	6	60	9,50 \$
001-RC0194	8" Prof. Kargaburun	6	60	11,50 \$

KOD	ÜRÜN	6	60	FİYAT
001-RC0176	6" Craft Kargaburun	6	60	9,50 \$

COMBINATION PLIER

ELEKTRİKÇİ PENSE

MAX. 1000V



DÖVME ÇELİK

KOD	ÜRÜN	6	60	FİYAT
001-RC0126	Elektrikçi Pense 6"	6	60	10,00 \$
001-RC0127	Elektrikçi Pense 7"	6	60	11,00 \$
001-RC0128	Elektrikçi Pense 8"	6	60	12,00 \$



SIDE CUTTING PLIER

ELEKTRİKÇİ YANKESKİ

MAX. 1000V



DÖVME ÇELİK

KOD	ÜRÜN	6	60	FİYAT
001-RC0129	Elektrikçi Yankeski 6"	6	60	10,00 \$



LONG NOSE PLIER

ELEKTRİKÇİ KARGABURUN

MAX. 1000V



DÖVME ÇELİK

KOD	ÜRÜN	6	60	FİYAT
001-RC0130	Elektrikçi Kargaburun 6"	6	60	10,00 \$



OFFSET COMBINATION PLIER

OFSET ELEKTRİKÇİ PENSE

MAX. 1000V



DÖVME ÇELİK

KOD	ÜRÜN	6	60	FİYAT
001-RC0132	Ofset Elektrikçi Pense 7"	6	60	11,00 \$



MINI PILIER W/CUTTER

STEEL MINI PENSE

GRV

KOD	ÜRÜN	📦	📦	FİYAT
001-RC0235	Steel Mini Pense	12	120	5,10 \$



MINI DIAGONAL PILIER W/CUTTER

STEEL MINI YANKESKİ

GRV

KOD	ÜRÜN	📦	📦	FİYAT
001-RC0245	Steel Mini Yankeski	12	120	4,60 \$



L. NOSE PLIER (NO TEETH) W/CUTTER

STEEL MINI SEKMAN TIP KARGABURUN

GRV

KOD	ÜRÜN	📦	📦	FİYAT
001-RC0285	Steel Mini Sekman Tip Kargaburun	12	120	4,60 \$



L. NOSE PLIER W/TEETH & CUTTER THIN

STEEL MINI DIŞLI KESKİLİ KARGABURUN İNCE

GRV

KOD	ÜRÜN	📦	📦	FİYAT
001-RC0297	Steel Mini Kesikli K. İ.	12	120	4,60 \$



CIRCLIP PLIER INTERNAL STRAIGHT

DÖVME ÇELİK SEKMAN
PENSESİ DÜZ İÇ



Made in
Türkiye



KOD	ÜRÜN	6	72	FİYAT
001-RC5550	Sekman Pensesi Düz İç 5"	6	72	7,70 \$
001-RC3380	Sekman Pensesi Düz İç 7"	6	72	9,50 \$

CIRCLIP PLIER EXTERNAL BENT

DÖVME ÇELİK SEKMAN
PENSESİ EĞRİ DIŞ



Made in
Türkiye



KOD	ÜRÜN	6	72	FİYAT
001-RC5553	Sekman Pensesi Eğri Dış 5"	6	72	7,70 \$
001-RC3680	Sekman Pensesi Eğri Dış 7"	6	72	9,50 \$

CIRCLIP PLIER EXTERNAL STRAIGHT

DÖVME ÇELİK SEKMAN
PENSESİ DÜZ DIŞ



Made in
Türkiye



KOD	ÜRÜN	6	72	FİYAT
001-RC5552	Sekman Pensesi Düz Dış 5"	6	72	7,70 \$
001-RC3580	Sekman Pensesi Düz Dış 7"	6	72	9,50 \$

CIRCLIP PLIER INTERNAL BENT

DÖVME ÇELİK SEKMAN
PENSESİ EĞRİ İÇ



Made in
Türkiye



KOD	ÜRÜN	6	72	FİYAT
001-RC5551	Sekman Pensesi Eğri İç 5"	6	72	7,70 \$
001-RC3480	Sekman Pensesi Eğri İç 7"	6	72	9,50 \$

4PCS CIRCLIP PLIER SET

4PC SEKMAN SET



Made in
Türkiye



KOD	ÜRÜN	6	24	FİYAT
001-RC5554	Sekman Pense Seti 5"	6	24	32,00 \$
001-RC5557	Sekman Pense Seti 7"	6	24	38,50 \$



OBLIQUE-ANGLED SIDE CUTTER 8"

EĞRİ AÇILI YANKESKİ



Made in
Türkiye

GRV

KOD	ÜRÜN	6	48	FİYAT
001-RC0380	Eğri Açılı Yankeski 8"	6	48	6,00 \$
001-RC0379	Eğri Yankeski 8"	6	48	6,00 \$

TOP CUTTER

STEEL TEPE KERPETEN 6



Made in
Türkiye

GRV

KOD	ÜRÜN	6	60	FİYAT
001-RC0298	Steel Tepe Kerpeten 6	6	60	7,00 \$

BENT SHOE PLIER

DANALYA PENSE EĞRİ



Made in
Türkiye

GRV

KOD	ÜRÜN	6	36	FİYAT
001-RC0865	Danalya Pense Eğri	6	36	17,00 \$

SHOE PLIER

DANALYA PENSE



Made in
Türkiye

GRV

KOD	ÜRÜN	6	36	FİYAT
001-RC0866	Danalya Pense Düz	6	36	16,00 \$

SIENET PLIER

MÜHÜR PENSESİ

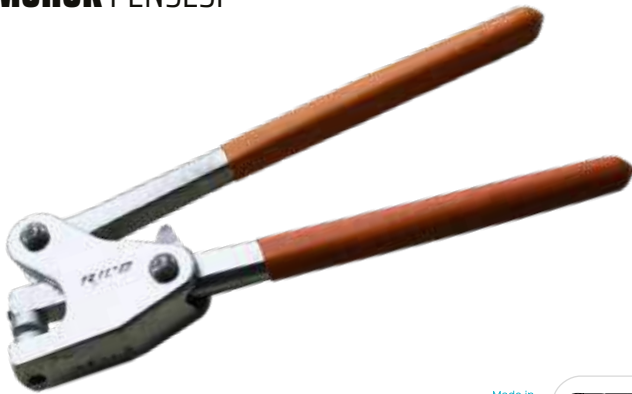

Made in
Türkiye

GRV

KOD	ÜRÜN	6	36	FİYAT
001-RC6620	Mühür Pensesi	6	36	20,00 \$



PROF. CARPENTER Pincer

PROF. KERPETENMade in
Türkiye

KOD	ÜRÜN	📦	📦	FİYAT
001-RC3307	Prof. Kerpeten 7"	10	80	7,10 \$

HORSOSHOER CARPENTER Pincer 10"

PROF. NALBANT K. 10"Made in
Türkiye

KOD	ÜRÜN	📦	📦	FİYAT
001-RC6510	Prof. Nalbant Kerpeten 10"	6	60	9,00 \$

KRAFT TOP CUTTER PLIER

KRAFT BETONCU KERPETENMade in
Türkiye

KOD	ÜRÜN	📦	📦	FİYAT
001-RC3410	Kraft Betoncu Kerpeten 10"	10	60	7,50 \$
001-RC3411	Kraft Betoncu Kerpeten 11"	10	48	9,00 \$

PROFESSIONAL NETWORK & PHONE PLIER

PROF. BİLGİSAYARCI KABLO PENSESİ

KOD	ÜRÜN	📦	📦	FİYAT
001-RC0874	Prof. Bilgisayarcı Kablo Pensesi	6	48	30,00 \$

LOCKING PLIER BLACK 704
AYARLI PENSE 10" 704
BEYAZ.



Made in Türkiye **GRV**

CRAFT WATER PUMP PLIER
CRAFT FORD PENSE



Made in Türkiye **GRV**

KOD	ÜRÜN	📦	📦	FİYAT
001-RC1907	Craft Ford Pense 7"	6	72	9,00 \$
001-RC1910	Craft Ford Pense 10"	6	60	12,85 \$

KOD	ÜRÜN	📦	📦	FİYAT
001-RC8302	Ayarlı Pense 704 Beyaz	6	48	18,25 \$

WATER PUMP PLIERS WITH SPRING
DÜĞMELİ FORD PENSE



Made in Türkiye **GRV**

KOD	ÜRÜN	📦	📦	FİYAT
001-RC1913	Düğmeli Ford Pense 10"	6	72	16,00 \$

WATER PUMP PLIER
STEEL FORD PENSE



Made in Türkiye **GRV**

PROF. WATER PUMP PLIERS WITH SPRING
PROF. DÜĞMELİ FORD PENSE



Made in Türkiye **GRV**

KOD	ÜRÜN	📦	📦	FİYAT
001-RC1508	Steel Ford Pense 8"	6	60	8,50 \$
001-RC1510	Steel Ford Pense 10"	6	48	13,00 \$
001-RC1512	Steel Ford Pense 12"	6	24	15,50 \$
001-RC1514	Steel Ford Pense 14"	6	24	19,00 \$

KOD	ÜRÜN	📦	📦	FİYAT
001-RC1917	Prof. Düğmeli Ford Pense 10"	6	72	33,00 \$

**PROFESYONEL
ÇÖZÜM ORTAĞINIZ**

RICO[®]
PROFESSIONAL

TORNAVİDA GRUPLARI

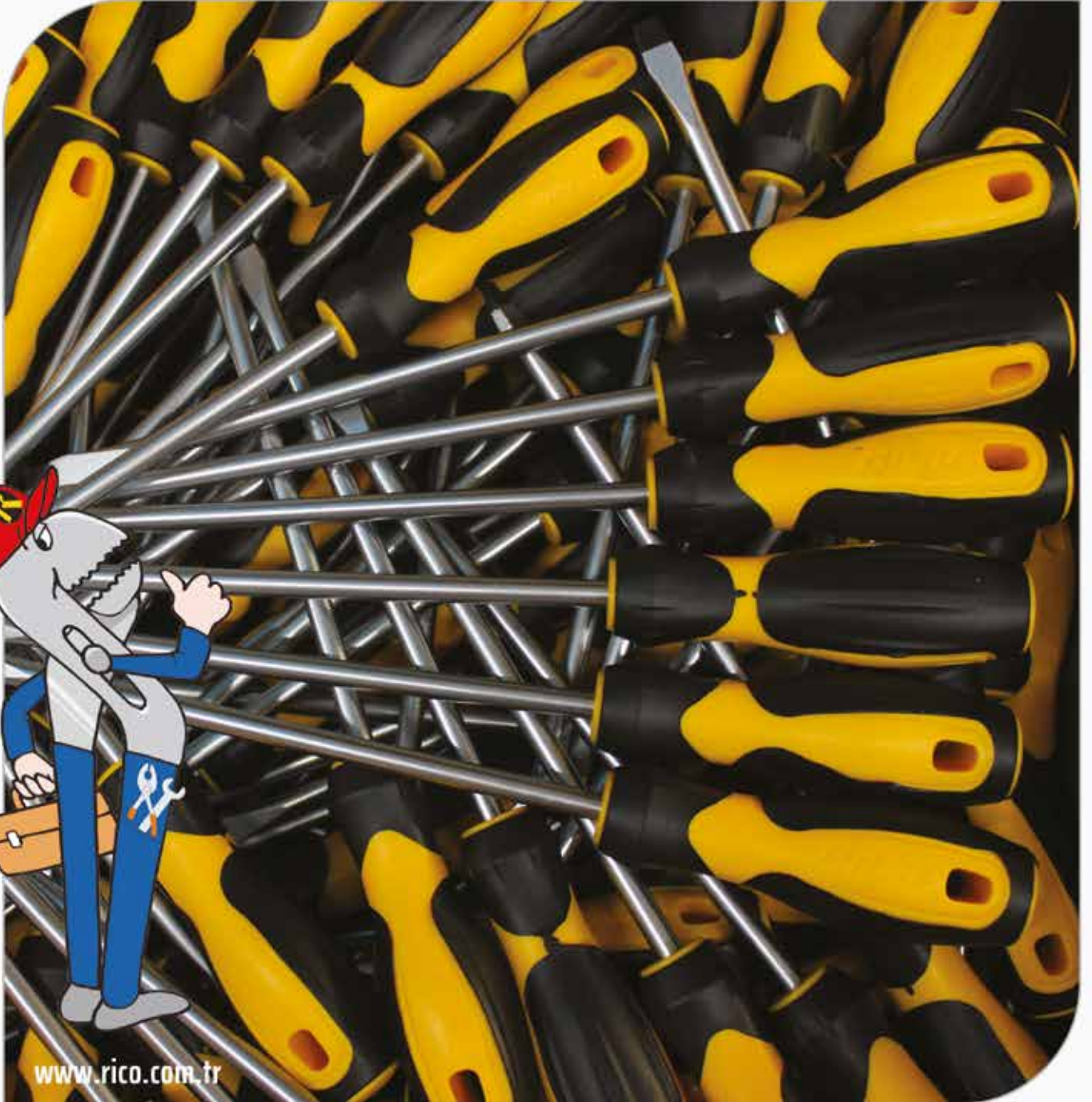

www.rico.com.tr

DIAMOND SERİSİ

Made in
Türkiye

GRV



PREMIUM SCREWDRIVERS

PREMIUM DIAMOND TORNAVİDALAR

Türk kullanıcısı tarafından özellikle talep edilen tornavida serisi

Hassas işlenmiş vidaya tam oturan dökülmeyen siyah elmas kaplamalı uçlar

Sertleştirilmiş Krom Molibden Çeliği

Kaymayı Önleyen Elmas Kaplama Uç Yapısı

Konforlu kavrama sağlayan, yağ, asit ve benzine dayanıklı sap



PREMIUM SCREWDRIVER SL

PREMIUM DIAMOND TORNAVİDA DÜZ



KOD	ÜRÜN	📦	📦	FİYAT
003-RD0970	3x080	12	600	2,10 \$
003-RD0971	4x100	12	300	2,60 \$
003-RD0972	4x125	12	300	2,79 \$
003-RD0973	4x150	12	300	2,97 \$
003-RD0974	5x100	12	240	3,15 \$
003-RD0975	5x125	12	240	3,35 \$
003-RD0976	5x150	12	240	3,52 \$
003-RD0977	6x100	12	180	3,70 \$
003-RD0978	6x125	12	180	4,05 \$
003-RD0979	6x150	12	180	4,35 \$



PREMIUM SCREWDRIVER PH

PREMIUM DIAMOND TORNAVİDA YILDIZ



KOD	ÜRÜN	📦	📦	FİYAT
003-RY9526	3x080	12	600	2,10 \$
003-RY9527	4x100	12	300	2,60 \$
003-RY9528	4x125	12	300	2,79 \$
003-RY9529	4x150	12	300	2,97 \$
003-RY9530	5x100	12	240	3,15 \$
003-RY9531	5x125	12	240	3,35 \$
003-RY9532	5x150	12	240	3,52 \$
003-RY9533	6x100	12	180	3,70 \$
003-RY9534	6x125	12	180	4,05 \$
003-RY9535	6x150	12	180	4,35 \$



7PCS PREMIUM SCREWDRIVER SET

7PC PREMIUM DIAMOND TORNAVİDA SETİ

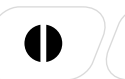

KOD	ÜRÜN	📦	📦	FİYAT
003-RC1900	7PC Premium Diamond Set	1	20	22,00 \$

ÜRÜN ÖZELLİKLERİ

Yıldız: 3x80mm, 5x100mm, 6x100mm
Düz: 3x80mm, 4x100mm, 6x100mm, 6x150mm

Made in
Türkiye



CRAFT SCREWDRIVERS

KRAFT TORNAVIDALAR

Türk kullanıcısı tarafından özellikle talep edilen tornavida serisi



Hassas işlenmiş vidaya tam oturan dökülmeyen kahverengi kaplamalı uçlar

Sertleştirilmiş Krom Vanadyum Çeliği

Konforlu kavrama sağlayan, yağ, asit ve benzine dayanıklı sap

CRAFT SCREWDRIVER SL

KRAFT TORNAVIDA DÜZ



CRAFT SCREWDRIVER PH

KRAFT TORNAVIDA YILDIZ



KOD	ÜRÜN	📦	📦	FİYAT
003-RD0375	3x080	12	600	1,46 \$
003-RD0310	3x100	12	600	1,59 \$
003-RD0312	3x125	12	300	1,66 \$
003-RD0475	4x080	12	300	1,72 \$
003-RD0410	4x100	12	300	1,79 \$
003-RD0412	4x125	12	300	1,92 \$
003-RD0415	4x150	12	300	2,05 \$
003-RD0416	4x250	12	300	2,48 \$
003-RD0510	5x100	12	240	2,17 \$
003-RD0512	5x125	12	240	2,30 \$
003-RD0515	5x150	12	240	2,43 \$
003-RD0525	5x250	12	120	2,86 \$
003-RD0610	6x100	12	180	2,55 \$
003-RD0612	6x125	12	180	2,80 \$
003-RD0615	6x150	12	180	3,00 \$
003-RD0620	6x200	12	180	3,32 \$
003-RD0630	6x300	6	120	3,63 \$
003-RD0815	8x150	12	120	3,83 \$
003-RD0820	8x200	12	120	4,21 \$
003-RD0925	9.5x250	12	60	6,26 \$



KOD	ÜRÜN	📦	📦	FİYAT
003-RY0375	3x080	12	600	1,46 \$
003-RY0310	3x100	12	600	1,59 \$
003-RY0312	3x125	12	300	1,66 \$
003-RY4580	4x080	12	300	1,72 \$
003-RY0410	4x100	12	300	1,79 \$
003-RY0412	4x125	12	300	1,92 \$
003-RY0415	4x150	12	300	2,05 \$
003-RY0416	4x250	12	300	2,48 \$
003-RY0510	5x100	12	240	2,17 \$
003-RY0512	5x125	12	240	2,30 \$
003-RY0515	5x150	12	240	2,43 \$
003-RY0525	5x250	12	120	2,86 \$
003-RY0610	6x100	12	180	2,55 \$
003-RY0612	6x125	12	180	2,80 \$
003-RY0615	6x150	12	180	3,00 \$
003-RY0620	6x200	12	180	3,32 \$
003-RY0630	6x300	6	120	3,63 \$
003-RY0815	8x150	12	120	3,83 \$
003-RY0820	8x200	12	120	4,21 \$



7PCS CRAFT SCREWDRIVER SET

7PC KRAFT TORNAVIDA SETİ



KOD	ÜRÜN	📦	📦	FİYAT
003-RC1978	7PC Kraft Set	1	20	15,00 \$
003-RC1981	7PC Kraft Yıldız Set	1	20	16,55 \$
003-RC1980	7PC Kraft Düz Set	1	20	16,55 \$

ÜRÜN ÖZELLİKLERİ

KRAFT SET

Yıldız: 3x80mm, 5x100mm, 6x100mm
Düz: 3x80mm, 5x100mm, 6x125mm, 6x150mm

YILDIZ KRAFT SET

Yıldız: 3x80mm, 4x100mm, 5x100mm, 5x125mm, 6x100mm, 6x125mm, 6x150mm

DÜZ KRAFT SET

Düz: 3x80mm, 4x100mm, 5x100mm, 5x125mm, 6x100mm, 6x125mm, 6x150mm



6PCS TORX STAR SCREWDRIVER SET/W TEMPERED

6PC TORX STAR TORNAVİDA



KOD	ÜRÜN	📦	📦	FİYAT
003-RT2522	6PC Torx	1	24	15,00 \$
003-RT2523	6PC Delikli	1	24	15,50 \$

ÜRÜN ÖZELLİKLERİ

T10, T15, T20, T25, T30, T40



CRAFT SCREWDRIVER PH & SL

TOPAÇ KRAFT TORNAVİDA



Made in
Türkiye

KOD	ÜRÜN	📦	📦	FİYAT
003-RY0062	6.0x38 Y.	12	300	1,80 \$
003-RD0062	6.0x38 D.	12	300	1,80 \$



TORX STAR SCREWDRIVER

TORX STAR TORNAVİDA



Made in
Türkiye

KOD	ÜRÜN	📦	📦	FİYAT
003-RT2510	T10X100	12	240	1,80 \$
003-RT2511	T15X100	12	240	1,98 \$
003-RT2512	T20X100	12	240	2,17 \$
003-RT2513	T25X100	12	240	2,32 \$
003-RT2524	T27X100	12	240	2,55 \$
003-RT2514	T30X100	12	240	2,73 \$
003-RT2525	T35X100	12	240	2,96 \$
003-RT2515	T40X100	12	240	3,08 \$
003-RT0020	T20X300	12	240	3,36 \$
003-RT0021	T25X300	12	240	3,65 \$
003-RT0022	T30X300	12	240	3,83 \$



TORX STAR SCREWDRIVER WITH TEMPERED

TORX STAR TORNAVİDA DELİKLİ



Made in
Türkiye

KOD	ÜRÜN	📦	📦	FİYAT
003-RT2516	T10	12	240	1,80 \$
003-RT2517	T15	12	240	1,98 \$
003-RT2518	T20	12	240	2,17 \$
003-RT2519	T25	12	240	2,32 \$
003-RT2526	T27	12	240	2,55 \$
003-RT2520	T30	12	240	2,73 \$
003-RT2527	T35	12	240	2,96 \$
003-RT2521	T40	12	240	3,08 \$

ÜRÜN ÖZELLİKLERİ

Krom vanadyum molibden çeliği, mat krom kaplı yüzey
Vıdaya tam oturum sağlayan hassas toleranslarda işlenmiş uçlar



IMPACT SCREWDRIVER PH

DARBELİ TORNAVİDA YILDIZ



KOD	ÜRÜN	📦	📦	FİYAT
003-RY6610	6X100	12	120	5,35 \$
003-RY6612	6X125	12	120	5,75 \$
003-RY6615	6X150	12	120	5,87 \$
003-RY8820	8X200	6	72	7,65 \$

ÜRÜN ÖZELLİKLERİ

Krom vanadyum molibden çeliği, mat krom kaplı yüzey
Vıdaya tam oturum sağlayan hassas toleranslarda işlenmiş uçlar
Yüksek güç aktarımı için anahtar somunlu dizayn

Made in
Türkiye



IMPACT SCREWDRIVER SL

DARBELİ TORNAVİDA DÜZ



KOD	ÜRÜN	📦	📦	FİYAT
003-RD6610	6X100	12	120	5,35 \$
003-RD6612	6X125	12	120	5,75 \$
003-RD6615	6X150	12	120	5,87 \$
003-RD8820	8X200	6	72	7,65 \$
003-RD8825	8X250	6	72	9,57 \$
003-RD8822	9.5X250	6	60	11,48 \$

ÜRÜN ÖZELLİKLERİ

Krom vanadyum molibden çeliği, mat krom kaplı yüzey
Vıdaya tam oturum sağlayan hassas toleranslarda işlenmiş uçlar
Yüksek güç aktarımı için anahtar somunlu dizayn

Made in
Türkiye



NUT DRIVER

LOKMA TORNAVİDALAR



Made in Türkiye GRV

KOD	ÜRÜN	📦	📦	FİYAT
003-RL05,5	Lokma Tornavida 5,5 mm	12	240	3,40 \$
003-RL0006	Lokma Tornavida 6 mm	12	240	3,50 \$
003-RL0007	Lokma Tornavida 7 mm	12	240	3,70 \$
003-RL0008	Lokma Tornavida 8 mm	12	240	4,00 \$
003-RL0009	Lokma Tornavida 9 mm	12	240	4,10 \$
003-RL0010	Lokma Tornavida 10 mm	12	240	4,25 \$
003-RL0011	Lokma Tornavida 11 mm	12	120	4,40 \$
003-RL0012	Lokma Tornavida 12 mm	12	120	4,77 \$
003-RL0013	Lokma Tornavida 13 mm	12	120	5,10 \$
003-RL0014	Lokma Tornavida 14 mm	12	120	5,25 \$

1/4" BIT HOLDER

1/4" BİTS TUTUCU



Made in Türkiye GRV

KOD	ÜRÜN	📦	📦	FİYAT
003-RK0021	Bits Tutucu 1/4" x 100 mm	12	120	2,50 \$

5PCS LONG NUT DRIVER SET

5PC LOKMA TORNAVİDA SETİ



KOD	ÜRÜN	📦	📦	FİYAT
003-RL0015	5PC Lokma Tornavida Seti	4	24	22,00 \$

İÇİNDEKİLER

6 mm, 7 mm, 8 mm, 10 mm, 13 mm

Made in Türkiye

4-IN-1 PRECISION SCREWDRIVER SET

4-IN-1 TELEFONCU TORNAVİDA



GRV

KOD	ÜRÜN	📦	📦	FİYAT
003-RC0040	4-IN-1 Telefoncu Tornavida	12	288	1,80 \$

36PCS CLASSICAL SCREWDRIVER SET

36PC TORNAVİDA KLASİK SET



KOD	ÜRÜN	📦	📦	FİYAT
003-RK0025	36PC Tornavida Klasik Set	3	12	26,50 \$

İÇİNDEKİLER

10 Parça Mikro Elektronikçi Tornavida
Düz: 2.5x50mm, 3.0x50mm
Yıldız: 0.0x50mm, 0x50mm
Torx: T5, T6, T7, T8, T9, T10x50 mm

1 Adet Bits Tutucu Tornavida
Bits Uçları: Düz: 4, 5, 6, 7
Yıldız: PH1, PH2, PH3, PZ1, PZ2, PZ3
Torx: T15, T20, T25, T30, PZ3

7 Parça Tornavida
Düz: 6x38mm, 5x75mm, 6x100mm, 8x150mm
Yıldız: 6x38mm, 5x75mm, 6x100mm

KLASİK SERİSİ

 Made in
Türkiye
GRV

CLASSICAL STRAIGHT SCREWDRIVER SL

KLASİK TORNAVIDALAR DÜZ

 Made in
Türkiye

KOD	ÜRÜN	📦	📦	FİYAT
003-RK0001	3x80 mm	12	120	1,16 \$
003-RK0034	3x100 mm	12	120	1,27 \$
003-RK0035	3x125 mm	12	120	1,33 \$
003-RK0002	4x100 mm	12	120	1,42 \$
003-RK0036	4x125 mm	12	120	1,54 \$
003-RK0037	4x150 mm	12	120	1,65 \$
003-RK0038	4x250 mm	12	120	1,97 \$
003-RK0003	5x100 mm	12	120	1,72 \$
003-RK0004	5x125 mm	12	120	1,85 \$
003-RK0005	5x150 mm	12	120	1,97 \$
003-RK0044	5x250 mm	12	120	2,30 \$
003-RK0006	6x100 mm	12	120	2,11 \$
003-RK0007	6x125 mm	12	120	2,32 \$
003-RK0008	6x150 mm	12	120	2,51 \$
003-RK0049	6x300 mm	12	120	4,08 \$
003-RK0046	8x150 mm	12	120	3,19 \$
003-RK0009	8x200 mm	12	120	3,45 \$
003-RD0932	9,5x250 mm	12	120	5,33 \$

ÜRÜN ÖZELLİKLERİ

Krom vanadyum molibden çeliği, mat krom kaplı yüzey
Geliştirilmiş ergonomik sap

TORX STAR SCREWDRIVER

TORX STAR TORNAVIDA KLASİK

 Made in
Türkiye

KOD	ÜRÜN	📦	📦	FİYAT
003-RT1010	T10X100	12	120	1,59 \$
003-RT1011	T15X100	12	120	1,72 \$
003-RT1012	T20X100	12	120	1,91 \$
003-RT1014	T25X100	12	120	1,97 \$
003-RT1016	T27X100	12	120	2,22 \$
003-RT1017	T30X100	12	120	2,32 \$
003-RT1019	T35X100	12	120	2,50 \$
003-RT1020	T40X100	12	120	2,67 \$
003-RT1013	T20X300	12	120	2,94 \$
003-RT1015	T25X300	12	120	3,07 \$
003-RT1018	T30X300	12	120	3,19 \$

ÜRÜN ÖZELLİKLERİ

Krom vanadyum molibden çeliği, mat krom kaplı yüzey
Geliştirilmiş ergonomik sap

CLASSICAL SCREWDRIVER STAR PH

KLASİK TORNAVIDALAR YILDIZ

 Made in
Türkiye

KOD	ÜRÜN	📦	📦	FİYAT
003-RK0011	3x80 mm	12	120	1,16 \$
003-RK0039	3x100 mm	12	120	1,27 \$
003-RK0040	3x125 mm	12	120	1,33 \$
003-RK0012	4x100 mm	12	120	1,42 \$
003-RK0041	4x125 mm	12	120	1,54 \$
003-RK0042	4x150 mm	12	120	1,65 \$
003-RK0043	4x250 mm	12	120	1,97 \$
003-RK0013	5x100 mm	12	120	1,72 \$
003-RK0014	5x125 mm	12	120	1,85 \$
003-RK0015	5x150 mm	12	120	1,97 \$
003-RK0045	5x250 mm	12	120	2,30 \$
003-RK0016	6x100 mm	12	120	2,11 \$
003-RK0017	6x125 mm	12	120	2,32 \$
003-RK0018	6x150 mm	12	120	2,51 \$
003-RK0048	6x300 mm	12	120	4,08 \$
003-RK0047	8x150 mm	12	120	3,19 \$
003-RK0019	8x200 mm	12	120	3,45 \$

ÜRÜN ÖZELLİKLERİ

Krom vanadyum molibden çeliği, mat krom kaplı yüzey
Geliştirilmiş ergonomik sap

TORX STAR SCREWDRIVER WITH TEMPERED

TORX STAR TORNAVIDA DELİKLİ

 Made in
Türkiye

KOD	ÜRÜN	📦	📦	FİYAT
003-RT1021	T10X100	12	120	1,59 \$
003-RT1022	T15X100	12	120	1,72 \$
003-RT1023	T20X100	12	120	1,91 \$
003-RT1024	T25X100	12	120	1,97 \$
003-RT1025	T27X100	12	120	2,22 \$
003-RT1026	T30X100	12	120	2,32 \$
003-RT1027	T35X100	12	120	2,50 \$
003-RT1028	T40X100	12	120	2,67 \$

ÜRÜN ÖZELLİKLERİ

Krom vanadyum molibden çeliği, mat krom kaplı yüzey
Geliştirilmiş ergonomik sap

7PCS CLASSICAL SCREWDRIVER SET

7PC TORNAVİDA KLASİK SET



KOD	ÜRÜN	☐	📦	FİYAT
003-RK0026	7PC Tornavida Klasik Set	6	24	13,00 \$

İÇİNDEKİLER

Düz: 3x75mm, 5x100mm, 6x125mm, 6x150mm
Yıldız: 3x75mm, 5x100mm, 6x100mm

Made in
Türkiye

6PCS TORX CLASIC SCREWDRIVER SET

6PC TORX TORNAVİDA KLASİK SET



KOD	ÜRÜN	☐	📦	FİYAT
003-RK0051	6PC Torx Tornavida Klasik Set	6	24	13,00 \$
003-RK0052	6PC Torx Tornavida Klasik Set Delikli	6	24	13,50 \$

İÇİNDEKİLER

T. 10x100mm, T. 15x100mm, T. 20x100mm, T. 25x100mm
T. 30x100mm, T. 40x100mm

Made in
Türkiye

2PCS CLASSICAL SPINNING TOP SCREWDRIVER SET

2 PC TOPAÇ TORNAVİDA KLASİK SET



KOD	ÜRÜN	☐	📦	FİYAT
003-RK0030	2 PC Topaç Tornavida Klasik Set	10	80	3,10 \$

İÇİNDEKİLER

Düz: 6x38mm Yıldız: 6x38mm

CLASSICAL SPINNING TOP SCREWDRIVER

TOPAÇ KLASİK TORNAVİDA



KOD	ÜRÜN	☐	📦	FİYAT
003-RK0053	Klasik Tornavida 6x38 mm Düz	12	120	1,65 \$
003-RK0054	Klasik Tornavida 6x38 mm Yıldız	12	120	1,65 \$

9PCS CLASSICAL PRECISION SCREWDRIVER SET

9PC HASSAS TORNAVİDA KLASİK SET



KOD	ÜRÜN	☐	📦	FİYAT
003-RK0033	9PC Hassas Tornavida Klasik Set	6	36	10,30 \$

İÇİNDEKİLER

1,5x50mm, 2,0x50mm, 2,5x50mm | T5x50mm, T6x50mm, T7x50mm
PH0x50mm, PH00x50mm, PH000x50mm

Made in
Türkiye



6PCS PRECISION CLASSIC SCREWDRIVER SET

6PC KRAFT TORX ELEKTRONİKÇİ KLEMENS
TORNAVIDA SETİ 25 - 50MM



KOD	ÜRÜN	📦	📦	FİYAT
003-KK1971	6PC Elektronikçi Klemens Torx Set 50mm	12	48	6,20 \$

İÇİNDEKİLER

T5 X 50mm , T6 X 50mm , T7 X 50mm , T8 X 50mm , T9 X 50mm , T10 X 50mm

6PCS CRAFT SCREWDRIVER SET

6PC KRAFT ELEKTRONİKÇİ KLEMENS
TORNAVIDA SETİ 50MM



KOD	ÜRÜN	📦	📦	FİYAT
003-KK1969	6PC Elektronikçi Klemens Set	1	48	6,20 \$

İÇİNDEKİLER

PH1 X 50mm , PH0 X 50mm , PH00 X 50mm , SL1.5 X 50mm , SL2.0 X 50mm , SL2.5 X 50mm

PRECISION SCREWDRIVER SL

MİKRO ELEKTRONİKÇİ KLEMENS TORN. DÜZ



Made in Türkiye



KOD	ÜRÜN	📦	📦	FİYAT
003-RD0923	Mikro Elektronikçi Düz Torn. SL 1.5x50mm	12	240	0,90 \$
003-RD0922	Mikro Elektronikçi Düz Torn. SL 2.0x50mm	12	240	0,90 \$
003-RD0928	Mikro Elektronikçi Düz Torn. SL 2.5x50mm	12	240	0,90 \$
003-RD0929	Mikro Elektronikçi Düz Torn. SL 3.0x50mm	12	240	0,90 \$
003-RD0958	Mikro Elektronikçi Düz Torn. SL 2.0x75mm	12	240	1,10 \$
003-RD0959	Mikro Elektronikçi Düz Torn. SL 2.5x75mm	12	240	1,10 \$
003-RD0960	Mikro Elektronikçi Düz Torn. SL 3.0x75mm	12	240	1,10 \$

PRECISION SCREWDRIVER PH

MİKRO ELEKTRONİKÇİ KLEMENS TORN. YILDIZ



Made in Türkiye



KOD	ÜRÜN	📦	📦	FİYAT
003-RD0927	Mikro Elektronikçi Yıldız Torn. PH 00x50mm	12	240	0,90 \$
003-RD0926	Mikro Elektronikçi Yıldız Torn. PH 0x50mm	12	240	0,90 \$
003-RD0921	Mikro Elektronikçi Yıldız Torn. PH 1x50mm	12	240	0,90 \$
003-RD0961	Mikro Elektronikçi Yıldız Torn. PH 00x75mm	12	240	1,10 \$
003-RD0962	Mikro Elektronikçi Yıldız Torn. PH 0x75mm	12	240	1,10 \$
003-RD0963	Mikro Elektronikçi Yıldız Torn. PH 1x75mm	12	240	1,10 \$

PRECISION SCREWDRIVER TORX

50mm MİKRO ELEKTRONİKÇİ KLEMENS TORNAVIDA TORX



Made in Türkiye



KOD	ÜRÜN	📦	📦	FİYAT
003-RD0930	Mikro Elektronikçi Klemens Torn. T5x50mm	12	240	0,90 \$
003-RD0931	Mikro Elektronikçi Klemens Torn. T6x50mm	12	240	0,90 \$
003-RD0947	Mikro Elektronikçi Klemens Torn. T7x50mm	12	240	0,90 \$
003-RD0948	Mikro Elektronikçi Klemens Torn. T8x50mm	12	240	0,90 \$
003-RD0949	Mikro Elektronikçi Klemens Torn. T9x50mm	12	240	0,90 \$
003-RD0950	Mikro Elektronikçi Klemens Torn. T10x50mm	12	240	0,90 \$

PRECISION SCREWDRIVER TORX

75mm MİKRO ELEKTRONİKÇİ KLEMENS TORNAVIDA TORX



Made in Türkiye



KOD	ÜRÜN	📦	📦	FİYAT
003-RD0964	Mikro Elektronikçi Klemens Torn. T5x75mm	12	240	1,10 \$
003-RD0965	Mikro Elektronikçi Klemens Torn. T6x75mm	12	240	1,10 \$
003-RD0966	Mikro Elektronikçi Klemens Torn. T7x75mm	12	240	1,10 \$
003-RD0967	Mikro Elektronikçi Klemens Torn. T8x75mm	12	240	1,10 \$
003-RD0968	Mikro Elektronikçi Klemens Torn. T9x75mm	12	240	1,10 \$
003-RD0969	Mikro Elektronikçi Klemens Torn. T10x75mm	12	240	1,10 \$

2-IN-1 SCREWDRIVER RED&BLUE HANDLE

2-IN-1 TORNAVİDA

KOD	ÜRÜN	📦	📦	FİYAT
005-RC2225	2-IN-1 Tornavida Mavi	6	120	6,50 \$
003-RC0021	2-IN-1 Tornavida Kırmızı	6	120	6,50 \$

6-IN-1 SCREWDRIVER BLUE&RED HANDLE

6-IN-1 ŞEFFAF BİTS TUTUCU TORNAVİDA

KOD	ÜRÜN	📦	📦	FİYAT
005-RC2232	6-IN1 Şeffaf Bits Tut. T. Kırmızı	6	120	6,00 \$
005-RC2237	6-IN1 Şeffaf Bits Tut. T. Mavi	6	120	6,00 \$

2-IN-1 SCREWDRIVER RED&BLUE HANDLE

2-IN-1 TORNAVİDA

KOD	ÜRÜN	📦	📦	FİYAT
003-RD0821	2-IN-1 Kraft Tornavida Kırmızı	12	120	2,60 \$

15PCS IMPACT SCREWDRIVER SET

15PC DARBELİ TORNAVİDA SETİ

KOD	ÜRÜN	📦	📦	FİYAT
005-RC2215	15PC Darbeli Tornavida Seti	1	20	36,00 \$

1/4" 30PCS SECURITY BITS SET

1/4" 30PC ŞEFFAF BITS SETTürkiye
Made In

KOD	ÜRÜN	📦	📦	FİYAT
005-RC2321	1/4" 30PC Şeffaf Bits Set	1	36	11,00 \$

ELECTRICAL TESTER SMALL SIZE

PROF. KONTROL KALEMİ KÜÇÜK



KOD	ÜRÜN	12	600	FİYAT
004-RC0001	Küçük	12	600	3,22 \$

ÜRÜN ÖZELLİKLERİ

Süngerler yüksek kalite CrV çeliğinden üretilmiştir.
Parlak krom kaplama
100-500V arası test kapasitesi



ELECTRICAL TESTER BIG SIZE

PROF. KONTROL KALEMİ BÜYÜK



KOD	ÜRÜN	12	300	FİYAT
004-RC0002	Büyük	12	300	3,50 \$

ÜRÜN ÖZELLİKLERİ

Süngerler yüksek kalite CrV çeliğinden üretilmiştir.
Parlak krom kaplama
100-500V arası test kapasitesi



CLASSICAL ELECTRICAL TESTER SMALL

KLASİK KONTROL KALEMİ KÜÇÜK



KOD	ÜRÜN	12	720	FİYAT
004-RC0005	K. Küçük	12	720	1,00 \$

ÜRÜN ÖZELLİKLERİ

Süngerler yüksek kalite CrV çeliğinden üretilmiştir.
Parlak krom kaplama
100-500V arası test kapasitesi



CLASSICAL ELECTRICAL TESTER BIG

KLASİK KONTROL KALEMİ BÜYÜK



KOD	ÜRÜN	12	600	FİYAT
004-RC0004	K. Büyük	12	600	1,15 \$

ÜRÜN ÖZELLİKLERİ

Süngerler yüksek kalite CrV çeliğinden üretilmiştir.
Parlak krom kaplama
100-500V arası test kapasitesi



DIGITAL CONTROL ITEM

DİJİTAL KONTROL KALEMİ



KOD	ÜRÜN	12	240	FİYAT
004-RC0006	Dijital	12	240	3,30 \$



CAR BATTERY TESTER

OTO KONTROL KALEMİ

KOD	ÜRÜN	3	3	FİYAT
004-RC0009	Oto Kontrol Kalem Düz	12	240	3,50 \$



CAR BATTERY TESTER FLEXIBLE

OTO KONTROL KALEMİ

KOD	ÜRÜN	3	3	FİYAT
004-RC0008	Oto Kontrol Kalem Spiralli	12	240	3,70 \$



CIRCUIT TESTER

OTO KONTROL KALEMİ

KOD	ÜRÜN	3	3	FİYAT
004-RC0003	Oto Kontrol Kalem	6	60	4,60 \$



8PCS HOBBY KNIFE SET

8PC MAKET BIÇAĞI SETİ

KOD	ÜRÜN	3	3	FİYAT
019-KK7001	8PC Maket Bıçağı Seti	6	24	6,50 \$



**PROFESYONEL
ÇÖZÜM ORTAĞINIZ**

RICO[®]
PROFESSIONAL

ALLEN GRUPLARI



www.rico.com.tr

9PCS LONG HEX KEY WRENCH

9PC ALLEN ANAHTAR DÜZ UZUNMade in
Türkiye

GRV



KOD	ÜRÜN	10	60	FİYAT
013-RC0215	9PC Allen Anahtar Düz Uzun	10	60	12,10 \$

ÜRÜN ÖZELLİKLERİ

Yüksek Kaliteli S2 Çeliğinden Üretilmiştir. 1,5mm, 2mm, 2,5mm, 3mm, 4mm, 5mm, 6mm, 8mm, 10mm

9PCS HEX KEY WRENCH

9PC ALLEN ANAHTAR DÜZ KISAMade in
Türkiye

GRV



KOD	ÜRÜN	12	72	FİYAT
013-RC2899	9PC Allen Anahtar Düz Kısa	12	72	9,10 \$

ÜRÜN ÖZELLİKLERİ

Yüksek Kaliteli S2 Çeliğinden Üretilmiştir. 1,5mm, 2mm, 2,5mm, 3mm, 4mm, 5mm, 6mm, 8mm, 10mm

9PCS LONG STAR KEY WRENCH

9PC TORX ALLEN ANAHTAR UZUNMade in
Türkiye

GRV



KOD	ÜRÜN	10	60	FİYAT
013-RC0207	9PC Torx Allen Anahtar Uzun	10	60	14,00 \$

ÜRÜN ÖZELLİKLERİ

Yüksek Kaliteli S2 Çeliğinden Üretilmiştir. T10, T15, T20, T25, T27, T30, T40, T45, T50

9PCS STAR KEY WRENCH

9PC TORX ALLEN ANAHTAR KISAMade in
Türkiye

GRV



KOD	ÜRÜN	12	72	FİYAT
013-RC3199	9PC Torx Allen Anahtar Kısa	12	72	12,00 \$

ÜRÜN ÖZELLİKLERİ

Yüksek Kaliteli S2 Çeliğinden Üretilmiştir. T10, T15, T20, T25, T27, T30, T40, T45, T50

9PCS LONG TAMPER STAR KEY WRENCH

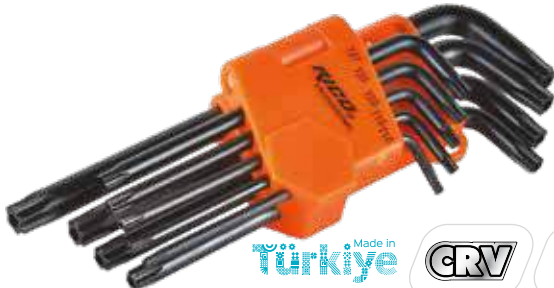
9PC DELİKLİ TORX ALLEN ANAHTAR UZUNMade in
Türkiye

GRV



KOD	ÜRÜN	10	60	FİYAT
013-RC9998	9PC Delikli Torx Allen Anh. Uzun	10	60	15,50 \$

ÜRÜN ÖZELLİKLERİ

Yüksek Kaliteli S2 Çeliğinden Üretilmiştir. T10, T15, T20, T25, T27, T30, T40, T45, T50

9PCS TAMPER STAR KEY WRENCH

9PC DELİKLİ TORX ALLEN ANAHTAR KISAMade in
Türkiye

GRV



KOD	ÜRÜN	12	72	FİYAT
013-RC9997	9PC Delikli Allen Torx Anh. Kısa	12	72	12,50 \$

ÜRÜN ÖZELLİKLERİ

Yüksek Kaliteli S2 Çeliğinden Üretilmiştir. T10, T15, T20, T25, T27, T30, T40, T45, T50

9PCS LONG BALL POINT HEX KEY WRENCH
9PC MİSKET BAŞLI ALLEN ANAHTAR UZUN

KOD	ÜRÜN	📦	📦	FİYAT
013-RC9999	9PC Misket Başlı Allen Anh.Uzun	10	60	12,90 \$

ÜRÜN ÖZELLİKLERİ

Yüksek Kaliteli S2 Çeliğinden Üretilmiştir. 1,5mm, 2mm, 2,5mm, 3mm, 4mm, 5mm, 6mm, 8mm, 10mm

9PCS BALL POINT HEX KEY WRENCH
9PC MİSKET BAŞLI ALLEN ANAHTAR KISA

KOD	ÜRÜN	📦	📦	FİYAT
013-RC3099	9PC Misket Başlı Allen Anh. Kısa	12	72	10,20 \$

ÜRÜN ÖZELLİKLERİ

Yüksek Kaliteli S2 Çeliğinden Üretilmiştir. 1,5mm, 2mm, 2,5mm, 3mm, 4mm, 5mm, 6mm, 8mm, 10mm

SHORT HEX KEY WRENCH
ALLEN ANAHTAR KISA

LONG HEX KEY WRENCH
ALLEN ANAHTAR UZUN

KOD	ÜRÜN	📦	📦	FİYAT
013-RC5060	Tek Allen Kısa 1,5 mm	300	3000	0,20 \$
013-RC5061	Tek Allen Kısa 2 mm	300	3000	0,22 \$
013-RC50625	Tek Allen Kısa 2,5 mm	300	3000	0,25 \$
013-RC5063	Tek Allen Kısa 3 mm	200	2400	0,38 \$
013-RC5064	Tek Allen Kısa 4 mm	100	2000	0,50 \$
013-RC5065	Tek Allen Kısa 5 mm	80	960	0,66 \$
013-RC5066	Tek Allen Kısa 6 mm	50	600	0,90 \$
013-RC5067	Tek Allen Kısa 7 mm	70	280	1,32 \$
013-RC5068	Tek Allen Kısa 8 mm	70	280	1,62 \$
013-RC5069	Tek Allen Kısa 9 mm	30	240	2,05 \$
013-RC5070	Tek Allen Kısa 10 mm	30	180	2,53 \$
013-RC5071	Tek Allen Kısa 11 mm	20	120	3,63 \$
013-RC5072	Tek Allen Kısa 12 mm	30	120	4,00 \$
013-RC5073	Tek Allen Kısa 13 mm	20	80	4,35 \$
013-RC5074	Tek Allen Kısa 14 mm	20	60	5,80 \$
013-RC5077	Tek Allen Kısa 17 mm	10	40	8,00 \$
013-RC5094	Tek Allen Kısa 19 mm	10	30	10,20 \$

KOD	ÜRÜN	📦	📦	FİYAT
013-RC5095	Tek Allen Uzun 1,5 mm	300	3000	0,22 \$
013-RC5096	Tek Allen Uzun 2 mm	300	3000	0,27 \$
013-RC5097	Tek Allen Uzun 2,5 mm	300	3000	0,33 \$
013-RC5098	Tek Allen Uzun 3 mm	200	2400	0,50 \$
013-RC5099	Tek Allen Uzun 4 mm	100	2000	0,60 \$
013-RC5100	Tek Allen Uzun 5 mm	80	960	0,77 \$
013-RC5101	Tek Allen Uzun 6 mm	50	600	1,10 \$
013-RC5102	Tek Allen Uzun 7 mm	70	280	1,62 \$
013-RC5103	Tek Allen Uzun 8 mm	70	280	1,98 \$
013-RC5104	Tek Allen Uzun 9 mm	30	240	2,55 \$
013-RC5105	Tek Allen Uzun 10 mm	30	180	3,05 \$
013-RC5106	Tek Allen Uzun 11 mm	20	120	4,40 \$
013-RC5107	Tek Allen Uzun 12 mm	30	120	4,95 \$
013-RC5108	Tek Allen Uzun 13 mm	20	80	5,40 \$
013-RC5109	Tek Allen Uzun 14 mm	20	60	7,00 \$
013-RC5110	Tek Allen Uzun 17 mm	10	40	10,20 \$
013-RC5111	Tek Allen Uzun 19 mm	10	30	13,00 \$

STAR HEX KEY WRENCH

TORX ALLEN ANAHTAR KISA



Made In
Türkiye

GRV



KOD	ÜRÜN	📦	📦	FİYAT
013-RC5112	Torx Allen Anahtar Kısa T10	12	120	0,57 \$
013-RC5113	Torx Allen Anahtar Kısa T15	12	120	0,66 \$
013-RC5114	Torx Allen Anahtar Kısa T20	12	120	0,79 \$
013-RC5115	Torx Allen Anahtar Kısa T25	12	120	0,90 \$
013-RC5116	Torx Allen Anahtar Kısa T27	12	120	1,05 \$
013-RC5117	Torx Allen Anahtar Kısa T30	12	120	1,25 \$
013-RC5118	Torx Allen Anahtar Kısa T35	12	120	1,40 \$
013-RC5119	Torx Allen Anahtar Kısa T40	12	48	1,54 \$
013-RC5120	Torx Allen Anahtar Kısa T45	12	48	1,70 \$
013-RC5121	Torx Allen Anahtar Kısa T50	12	48	2,00 \$

STAR HEX KEY WRENCH

TORX ALLEN ANAHTAR UZUN



Made In
Türkiye

GRV



KOD	ÜRÜN	📦	📦	FİYAT
013-RC5122	Torx Allen Anahtar Uzun T10	12	120	0,69 \$
013-RC5123	Torx Allen Anahtar Uzun T15	12	120	0,79 \$
013-RC5124	Torx Allen Anahtar Uzun T20	12	120	0,97 \$
013-RC5125	Torx Allen Anahtar Uzun T25	12	120	1,10 \$
013-RC5126	Torx Allen Anahtar Uzun T27	12	120	1,25 \$
013-RC5127	Torx Allen Anahtar Uzun T30	12	120	1,54 \$
013-RC5128	Torx Allen Anahtar Uzun T35	12	120	1,69 \$
013-RC5130	Torx Allen Anahtar Uzun T40	12	48	1,87 \$
013-RC5131	Torx Allen Anahtar Uzun T45	12	48	2,00 \$
013-RC5132	Torx Allen Anahtar Uzun T50	12	48	2,50 \$

8PCS FOLDING HEX KEY WRENCH

8PÇ ÇAKI TİP DÜZ ALLEN ANAHTAR



Made In
Türkiye

GRV



KOD	ÜRÜN	📦	📦	FİYAT
013-RC0204	8PÇ Çakı Tip Düz Allen Anh.	10	40	11,50 \$

ÜRÜN ÖZELLİKLERİ

Yüksek Kaliteli S2 Çeliğinden Üretilmiştir. 2,5mm, 3mm, 4mm, 5mm, 6mm, 7mm, 8mm, 10mm

8PCS FOLDING HEX KEY WRENCH

8PÇ ÇAKI TİP TORX ALLEN ANAHTAR



Made In
Türkiye

GRV



KOD	ÜRÜN	📦	📦	FİYAT
013-RC0203	8PÇ Çakı Tip Torx Allen Anh.	10	60	10,40 \$

ÜRÜN ÖZELLİKLERİ

Yüksek Kaliteli S2 Çeliğinden Üretilmiştir. T9, T10, T15, T20, T25, T27, T30, T40

5PCS T HANDLE HEX KEY SET
5PC T TİP DÜZ ALLEN

6PCS T HANDLE STAR ALLEN KEY SET
6PC T TİP TORX ALLEN

5PCS T HANDLE BALL POINT & HEX KEY S.
5PC MİSKET BAŞLI ALLEN

KOD	ÜRÜN	1	20	FİYAT
013-RC5185	5Pc Düz	1	20	19,25 \$

KOD	ÜRÜN	1	20	FİYAT
013-RC5187	6Pc Torx	1	20	22,75 \$

KOD	ÜRÜN	1	20	FİYAT
013-RC5186	5Pc Misket Başlı	1	20	21,00 \$

ÜRÜN ÖZELLİKLERİ

Yüksek Kaliteli S2 Çeliğinden Üretilmiştir.
3mm, 4mm, 5mm, 6mm, 8mm

ÜRÜN ÖZELLİKLERİ

Yüksek Kaliteli S2 Çeliğinden Üretilmiştir.
T10, T15, T20, T25, T27, T30, T40

ÜRÜN ÖZELLİKLERİ

Yüksek Kaliteli S2 Çeliğinden Üretilmiştir.
3mm, 4mm, 5mm, 6mm, 8mm

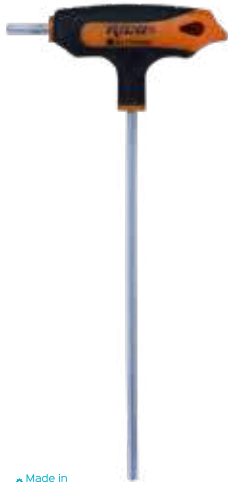
T HANDLE ALLEN KEYS
T TİP DÜZ ALLEN ANAHTAR

Made in
Türkiye



KOD	ÜRÜN	12	120	FİYAT
013-RC5161	2mm	12	120	2,30 \$
013-RC5162	2,5mm	12	120	2,40 \$
013-RC5163	3mm	12	120	2,65 \$
013-RC5164	4mm	12	120	3,00 \$
013-RC5165	5mm	12	120	3,50 \$
013-RC5166	6mm	12	120	4,12 \$
013-RC5168	8mm	12	120	4,85 \$
013-RC5170	10mm	12	48	7,25 \$

T HANDLE STAR ALLEN KEYS
T TİP TORX ALLEN ANAHTAR

Made in
Türkiye



KOD	ÜRÜN	12	180	FİYAT
013-RC5171	Torx T9	12	180	2,65 \$
013-RC5172	Torx T10	12	180	2,78 \$
013-RC5173	Torx T15	12	180	3,15 \$
013-RC5174	Torx T20	12	120	3,40 \$
013-RC5175	Torx T25	12	120	3,63 \$
013-RC5176	Torx T27	12	120	3,74 \$
013-RC5177	Torx T30	12	120	4,00 \$
013-RC5178	Torx T40	12	120	4,25 \$

T HANDLE ALLEN KEYS
T TİP MİSKET BAŞLI ALLEN

Made in
Türkiye



KOD	ÜRÜN	12	120	FİYAT
013-RC5179	3 mm	12	120	2,78 \$
013-RC5180	4 mm	12	120	3,15 \$
013-RC5181	5 mm	12	120	3,63 \$
013-RC5182	6 mm	12	120	4,25 \$
013-RC5183	8 mm	12	120	5,10 \$
013-RC5184	10 mm	12	120	7,50 \$

**PROFESYONEL
ÇÖZÜM ORTAĞINIZ**

RICO[®]
PROFESSIONAL

BITS UÇLAR



40PCS POWER BITS SET
40PC POWER BITS SET

KOD	ÜRÜN	📦	📦	FİYAT
005-KK0005	40PC Power Bits Set	1	10	38,00 \$

İÇİNDEKİLER

3/8" 10mm Adaptör - 1/2" 10mm Adaptör

30mm X H4 / H5 / H6 / H7 / H8 / H10 / H12 T20 / 25 / 30 / 40 / 45 / 50 / 55 M5 / M6 / M8 / M10 / M12

75mm X H4 / H5 / H6 / H7 / H8 / H10 / H12 T20 / 25 / 30 / 40 / 45 / 50 / 55 M5 / M6 / M8 / M10 / M12

19PCS IMPACT BITS SET W/HOLE
19PC KAPLAMALI DELİKLİ TORX BITS SET

KOD	ÜRÜN	📦	📦	FİYAT
005-KK0003	19PC Kaplamalı Delikli Torx Bits Set	1	24	18,00 \$

İÇİNDEKİLER

1/2" DR 10mm AD

30 mm X T20 / 25 / 30 / 35 / 40 / 45 / 50 / 55 / T60

75 mm X T20 / 25 / 30 / 35 / 40 / 45 / 50 / 55 / T60

19PCS IMPACT BITS SET
19PC KAPLAMALI TORX BITS SET

KOD	ÜRÜN	📦	📦	FİYAT
005-KK0002	19PC Kaplamalı Torx Bits Set	1	24	16,30 \$

İÇİNDEKİLER

1/2" DR 10mm AD

30 mm X T20 / 25 / 30 / 35 / 40 / 45 / 50 / 55 / T60

75 mm X T20 / 25 / 30 / 35 / 40 / 45 / 50 / 55 / T60

13PCS IMPACT BITS SET - SPLINE
13PC TORX KAPLAMALI BITS SET

KOD	ÜRÜN	📦	📦	FİYAT
005-KK0004	13PC Torx Kaplamalı Bits Set	1	24	14,20 \$

İÇİNDEKİLER

1/2" 10mm AD

30 mm X M5 / M6 / M8 / M10 / M12 / M14 75 mm X M5 / M6 / M8 / M10 / M12 / M14

15PCS IMPACT BITS SET - HEX
15PC KAPLAMALI ALLEN BITS SET

KOD	ÜRÜN	📦	📦	FİYAT
005-KK0001	15PC Kaplamalı Allen Bits Set	1	24	14,00 \$

İÇİNDEKİLER

1/2" 10mm AD

30 mm X H4 / H5 / H6 / H7 / H8 / H10 / H12 75 mm X H4 / H5 / H6 / H7 / H8 / H10 / H12

TORX BITS 10x30mm

1/4" YILDIZ BİTS UÇLAR (PHILIPS)



KOD	ÜRÜN	📦	📦	FİYAT
005-KK1134	Yıldız Bits Uç PH2 25mm	50	3600	0,20 \$
005-KK1135	Yıldız Bits Uç PH2 50mm	30	1800	0,43 \$
005-KK1136	Yıldız Bits Uç PH2 75mm	30	1200	0,71 \$
005-KK1137	Yıldız Bits Uç PH2 100mm	10	960	0,96 \$
005-KK1138	Yıldız Bits Uç PH2 150mm	10	720	1,78 \$
005-KK1139	Yıldız Bits Uç PH2 200mm	10	360	2,73 \$

INSERT BITS PH

1/4" YILDIZ BİTS UÇLAR (PHILIPS) KAPLAMALI



KOD	ÜRÜN	📦	📦	FİYAT
005-KK1209	Ph2 25mm Bits Uç (Philips)	50	3000	0,32 \$
005-KK1210	Ph2 50mm Bits Uç (Philips)	30	1800	0,51 \$
005-KK1211	Ph2 75mm Bits Uç (Philips)	30	1440	0,90 \$
005-KK1212	Ph2 100mm Bits Uç (Philips)	10	960	1,10 \$
005-KK1213	Ph2 150mm Bits Uç (Philips)	10	720	1,90 \$
005-KK1214	Ph2 200mm Bits Uç (Philips)	10	360	2,93 \$
005-KK0034	Ph3 50mm Bits Uç (Kalınlık 8mm)	10	1200	0,96 \$

INSERT BITS SL6 ZINC

1/4" DÜZ BİTS UÇLAR



KOD	ÜRÜN	📦	📦	FİYAT
005-KK1141	SL6 25mm Bits Uç	50	2800	0,20 \$
005-KK1032	SL6 50mm Bits Uç	30	1200	0,43 \$
005-KK1226	SL6 75mm Bits Uç	10	960	0,71 \$
005-KK1142	SL6 100mm Bits Uç	10	960	0,96 \$
005-KK1143	SL6 150mm Bits Uç	10	720	1,78 \$
005-KK1227	SL6 200mm Bits Uç	10	360	2,73 \$

INSERT BITS SL6

1/4" DÜZ BİTS UÇLAR (SL) KAPLAMALI



KOD	ÜRÜN	📦	📦	FİYAT
005-KK1234	SL6 25mm Bits Uç	50	2800	0,32 \$
005-KK1235	SL6 50mm Bits Uç	30	1200	0,51 \$
005-KK1236	SL6 75mm Bits Uç	10	960	0,90 \$
005-KK1237	SL6 100mm Bits Uç	10	960	1,10 \$
005-KK1238	SL6 150mm Bits Uç	10	720	1,90 \$
005-KK1239	SL6 200mm Bits Uç	10	360	2,93 \$

HEX BITS 50mm

1/4" ALLEN BİTS UÇ 50mm



KOD	ÜRÜN	📦	📦	FİYAT
005-KK1204	H3x50mm Allen Bits Uç Miknatıslı	30	1800	0,58 \$
005-KK1205	H4x50mm Allen Bits Uç Miknatıslı	30	1800	0,58 \$
005-KK1206	H5x50mm Allen Bits Uç Miknatıslı	30	1800	0,58 \$
005-KK1207	H6x50mm Allen Bits Uç Miknatıslı	30	1800	0,58 \$
005-KK1208	H7x50mm Allen Bits Uç Miknatıslı	30	1800	0,83 \$

INSERT BITS PZ2

1/4" PZ BİTS UÇLAR KAPLAMALI



KOD	ÜRÜN	📦	📦	FİYAT
005-KK1219	Pz2 Bits Uç 25mm	50	1800	0,27 \$
005-KK1220	Pz2 Bits Uç 50mm	30	1200	0,51 \$
005-KK1221	Pz2 Bits Uç 75mm	10	720	0,90 \$
005-KK1222	Pz2 Bits Uç 100mm	10	600	1,10 \$

TORX BITS 10x30mm

TORX BİTS UÇ H.10X30mm KAPLAMALI



TORX BITS 10x75mm

TORX BİTS UÇ H.10X75mm KAPLAMALI



KOD	ÜRÜN	📦	📦	FİYAT
005-KK1148	T20-10x30 Bits Uç	10	1200	0,76 \$
005-KK1149	T25-10x30 Bits Uç	10	1200	0,76 \$
005-KK1150	T27-10x30 Bits Uç	10	1200	0,76 \$
005-KK1151	T30-10x30 Bits Uç	10	1200	0,76 \$
005-KK11515	T35-10x30 Bits Uç	10	1200	0,76 \$
005-KK1152	T40-10x30 Bits Uç	10	1200	0,76 \$
005-KK1153	T45-10x30 Bits Uç	10	1200	0,76 \$
005-KK1154	T50-10x30 Bits Uç	10	1200	0,76 \$
005-KK1155	T55-10x30 Bits Uç	10	1200	0,76 \$
005-KK1156	T60-10x30 Bits Uç	10	1200	1,17 \$

HEX BITS 10x30mm

ALLEN BİTS UÇ H. 10X30mm KAPLAMALI



HEX BITS 10x75mm

ALLEN BİTS UÇ H. 10X75mm KAPLAMALI



KOD	ÜRÜN	📦	📦	FİYAT
005-KK1176	H4.10x30 Bits Uç	10	1000	0,76 \$
005-KK1177	H5.10x30 Bits Uç	10	1000	0,76 \$
005-KK1178	H6.10x30 Bits Uç	10	1000	0,76 \$
005-KK1179	H7.10x30 Bits Uç	10	1000	0,76 \$
005-KK1180	H8.10x30 Bits Uç	10	1000	0,76 \$
005-KK1181	H10.10x30 Bits Uç	10	1000	0,76 \$
005-KK1182	H12.10x30 Bits Uç	10	1000	1,17 \$

KOD	ÜRÜN	📦	📦	FİYAT
005-KK1183	H4. 10x75 Bits Uç	10	480	1,52 \$
005-KK1184	H5. 10x75 Bits Uç	10	480	1,52 \$
005-KK1185	H6. 0x75 Bits Uç	10	480	1,52 \$
005-KK1186	H7. 10x75 Bits Uç	10	480	1,52 \$
005-KK1187	H8. 10x75 Bits Uç	10	480	1,52 \$
005-KK1188	H10. 10x75 Bits Uç	10	480	1,52 \$
005-KK1189	H12. 10x75 Bits Uç	10	480	1,62 \$

SPLINE BITS M10x30mm

12 KÖŞE BİTS UÇ H.10X30mm KAPLAMALI



SPLINE BITS M10x75mm

12 KÖŞE BİTS UÇ H.10X75mm KAPLAMALI



KOD	ÜRÜN	📦	📦	FİYAT
005-KK1166	M5. 10x30 Bits Uç	10	1200	0,76 \$
005-KK1167	M6. 10x30 Bits Uç	10	1200	0,76 \$
005-KK1168	M8. 10x30 Bits Uç	10	1200	0,76 \$
005-KK1169	M10. 10x30 Bits Uç	10	1200	0,76 \$
005-KK1170	M12. 10x30 Bits Uç	10	1000	0,76 \$

KOD	ÜRÜN	📦	📦	FİYAT
005-KK1171	M5. 10X75mmBits Uç	10	480	1,52 \$
005-KK1172	M6. 10X75mmBits Uç	10	480	1,52 \$
005-KK1173	M8. 10X75mmBits Uç	10	480	1,52 \$
005-KK1174	M10. 10X75mmBits Uç	10	480	1,52 \$
005-KK1175	M12. 10X75mmBits Uç	10	360	1,62 \$

TORX BITS 50mm

1/4" TORX BITS UÇ 50mm KAPLAMALI



KOD	ÜRÜN	📦	📦	FİYAT
005-KK1190	T10x50mm Torx Bits Uç	30	1800	0,58 \$
005-KK1191	T15x50mm Torx Bits Uç	30	1800	0,58 \$
005-KK1192	T20x50mm Torx Bits Uç	30	1800	0,58 \$
005-KK1196	T25x50mm Torx Bits Uç	30	1800	0,58 \$
005-KK1193	T27x50mm Torx Bits Uç	30	1800	0,58 \$
005-KK1194	T30x50mm Torx Bits Uç	30	1200	0,58 \$
005-KK11965	T35x50mm Torx Bits Uç	30	1200	0,58 \$
005-KK1195	T40x50mm Torx Bits Uç	30	1200	0,58 \$
005-KK1223	T30x75mm Torx Bits Uç	30	1200	0,75 \$
005-KK1224	T30x100mm Torx Bits Uç	30	1200	1,00 \$
005-KK1225	T30x150mm Torx Bits Uç	30	1200	1,66 \$
005-KK2150	T20x150mm Torx Bits Uç	10	1200	1,66 \$
005-KK2151	T25x150mm Torx Bits Uç	30	1200	1,66 \$

TORX BITS 25mm

1/4" TORX BITS UÇ 25mm KAPLAMALI



KOD	ÜRÜN	📦	📦	FİYAT
005-KK1197	T10x25mm Torx Bits Uç	50	1800	0,35 \$
005-KK1198	T15x25mm Torx Bits Uç	50	1800	0,35 \$
005-KK1199	T20x25mm Torx Bits Uç	50	1800	0,35 \$
005-KK1200	T25x25mm Torx Bits Uç	50	1800	0,35 \$
005-KK1201	T27x25mm Torx Bits Uç	50	1800	0,35 \$
005-KK1202	T30x25mm Torx Bits Uç	50	1800	0,35 \$
005-KK1203	T40x25mm Torx Bits Uç	50	1800	0,35 \$

BITS POINT TORX

TORX BITS UÇ H.10X30mm (OTO)



KOD	ÜRÜN	📦	📦	FİYAT
005-RC2050	T20 Torx Bits Uç	20	400	0,63 \$
005-RC2051	T25 Torx Bits Uç	20	400	0,63 \$
005-RC2052	T27 Torx Bits Uç	20	400	0,63 \$
005-RC2053	T30 Torx Bits Uç	20	400	0,63 \$
005-RC2054	T40 Torx Bits Uç	20	400	0,63 \$
005-KK1073	T45 Torx Bits Uç	20	400	0,63 \$
005-RC2055	T50 Torx Bits Uç	20	400	0,63 \$
005-KK1074	T55 Torx Bits Uç	20	400	0,63 \$
005-RC2056	T60 Torx Bits Uç	10	400	0,80 \$

BITS POINT

YILDIZ BITS UÇLAR



KOD	ÜRÜN	📦	📦	FİYAT
005-KK1140	PH1 25mm Bits Uç	50	2800	0,20 \$
005-KK1021	Ph1-50mm Bits Uç	30	1200	0,43 \$
005-KK1125	Ph1-70mm Bits Uç	25	1000	0,51 \$
005-KK1035	Ph3-70mm Bits Uç	25	1000	0,51 \$
005-KK1036	Pz1-50mm Bits Uç	30	1200	0,43 \$
005-KK1037	Pz1-70mm Bits Uç	25	1000	0,51 \$
005-KK1040	Pz3-50mm Bits Uç	30	1200	0,43 \$
005-KK1041	Pz3-70mm Bits Uç	25	1000	0,51 \$

BITS POINT * YUKA BRAND

YUKA BİTS UÇLARI



BITS POINT SL6

DÜZ BİTS UÇLAR



KOD	ÜRÜN	📦	📦	FİYAT
005-YK1105	PH1 50mm Bits Uç	30	1200	0,25 \$
005-YK1305	PZ1 50mm Bits Uç	30	1200	0,25 \$
005-YK1405	PZ2 50mm Bits Uç	30	1200	0,25 \$
005-YK1505	SL5 50mm Bits Uç	30	1200	0,25 \$

KOD	ÜRÜN	📦	📦	FİYAT
005-KK1031	SL5-70mm Bits Uç	25	1000	0,51 \$
005-KK1032	SL6-50mm Bits Uç	30	1200	0,43 \$
005-KK1033	SL6-70mm Bits Uç	25	1000	0,51 \$

8PCS ALLEN BITS SET 50mm

8PC ALLEN BİTS UÇ SETİ 50mm



8PCS PH-SL BITS SET 50mm

8PC (PH-SL-PZ) BİTS UÇ SETİ 50mm



KOD	ÜRÜN	📦	📦	FİYAT
005-KK1132	8PC 50mm Bits Uç Seti	10	200	3,61 \$

KOD	ÜRÜN	📦	📦	FİYAT
005-KK1130	8PC 50mm Bits Uç Seti	10	200	3,61 \$

ÜRÜN ÖZELLİKLERİ

H1,5 X 50mm - H2 X 50mm - H2,5 X 50mm - H3 X 50mm - H4 X 50mm - H4,5 X 50mm - H5 X 50mm - H6 X 50mm

ÜRÜN ÖZELLİKLERİ

PH0 X 50mm - PH1 X 50mm - PH2 X 50mm - PH3 X 50mm - SL5 X 50mm - SL6 X 50mm - PZ1 X 50mm - PZ2 X 50mm

8PCS BITS PH2 X 50-75-100-150mm

8PC PH2 BİTS UÇ SETİ



10PCS TORX BITS SET 50mm

10PC TORX BİTS UÇ SETİ 50mm



KOD	ÜRÜN	📦	📦	FİYAT
005-KK1133	8PC Bits Uç Seti	10	80	7,18 \$

KOD	ÜRÜN	📦	📦	FİYAT
05-KK1131	10PC 50mm Bits Uç Seti	10	360	4,40 \$

ÜRÜN ÖZELLİKLERİ

PH2 X - 50mm - 75mm - 100mm - 150mm

ÜRÜN ÖZELLİKLERİ

50mm X T6 - T7 - T8 - T10 - T15 - T20 - T25 - T27 - T30 - T40

8PCS TORX BITS SET 150mm

**8PC KAPLAMALI
TORX BITS 150mm**



4PCS TORX BITS SET 150mm

**4PC KAPLAMALI
TORX BITS 150mm**



KOD	ÜRÜN	📦	📦	FİYAT
005-KK1124	8 Pç Kaplamalı Torx Bits Set 150mm	10	80	14,26 \$

ÜRÜN ÖZELLİKLERİ

150 mm X - T10 / T15 / T20 / T25 / T27 / T30 / T35 / 40

KOD	ÜRÜN	📦	📦	FİYAT
005-KK1123	4Pç Kaplamalı Torx Bits Set 150mm	10	80	7,13 \$

ÜRÜN ÖZELLİKLERİ

150 mm X - T10 / T15 / T20 / T25

NUT SETTER 45mm

**1/4" MANYETİK BITS
LOKMA AD. 45mm**



NUT SETTER 65mm

**1/4" MANYETİK BITS
LOKMA AD. 65mm**



KOD	ÜRÜN	📦	📦	FİYAT
005-KK1228	8mm Manyetik Bits Lokma 45mm	12	960	1,35 \$
005-KK1229	10mm Manyetik Bits Lokma 45mm	12	960	1,61 \$
005-KK1230	13mm Manyetik Bits Lokma 45mm	6	720	2,17 \$

KOD	ÜRÜN	📦	📦	FİYAT
005-KK1231	8mm Manyetik Bits Lokma 65mm	6	720	1,78 \$
005-KK1232	10mm Manyetik Bits Lokma 65mm	6	720	1,92 \$
005-KK1233	13mm Manyetik Bits Lokma 65mm	6	216	2,41 \$

1/4 BITS ADAPTER SET

1/4 BITS UÇ ADAPTÖR



2PCS BITS ADAPTER SET

2 PC BITS UÇ ADAPTÖR SETİ



1/2" SDS PLUS ADAPTER

1/2" SDS PLUS ADAPTÖR



KOD	ÜRÜN	📦	📦	FİYAT
005-KK1315	1/4" Bits Uç Adaptör	12	96	2,00 \$

KOD	ÜRÜN	📦	📦	FİYAT
005-KK1314	Bits Uç Ad. Seti 1/4" - 1/2"	10	120	4,00 \$

KOD	ÜRÜN	📦	📦	FİYAT
005-KK1216	1/2" Sds Plus Adaptör	12	96	6,00 \$

4PCS BITS SET 25MM - 50mm

4PC BITS UÇ SETİ
25MM - 50mm



4PCS BITS 25mm

4PC BITS UÇ SETİ 25mm



KOD	ÜRÜN	📦	📦	FİYAT
005-KK1146	4PC Bits Uç Seti	12	384	1,43 \$

ÜRÜN ÖZELLİKLERİ
SL6 X 25mm - SL6 X 50mm - PH2 X 25mm - PH2 X 50mm

KOD	ÜRÜN	📦	📦	FİYAT
005-KK1144	4PC Bits Uç Seti	12	432	1,22 \$

ÜRÜN ÖZELLİKLERİ
PH1 X 25mm - PH2 X 25mm - SL5 X 25mm - SL6 X 25mm

4PCS BITS 50mm

4PC BITS UÇ SETİ 50mm



6PCS BITS SET 25MM - 50mm

6PC BITS UÇ SETİ 25mm - 50mm



KOD	ÜRÜN	📦	📦	FİYAT
005-KK1145	4PC Bits Uç Seti	12	288	2,07 \$

ÜRÜN ÖZELLİKLERİ
PH1 X 50mm - PH2 X 50mm - SL5 X 50mm - SL6 X 50mm

KOD	ÜRÜN	📦	📦	FİYAT
005-KK1147	6PC Bits Uç Seti	10	240	2,18 \$

ÜRÜN ÖZELLİKLERİ
SL6 X 25mm - PH2 X 25mm - PZ2 X 25mm - SL6 X 50mm - PH2 X 50mm - PZ2 X 50mm

60MM MAGNETIC BITS HOLDER 60mm

MANYETİK BİTS TUTUCU 60mm

GRV

KOD	ÜRÜN	📦	📦	FİYAT
007-RC2007	Manyetik Bits Tutucu 60mm	12	240	4,35 \$

BITS HOLDER

BİTS TUTUCU

GRV

KOD	ÜRÜN	📦	📦	FİYAT
005-KK1059	Bits Tutucu 60mm	10	300	1,40 \$
005-KK1060	Bits Tutucu 75mm	10	300	1,63 \$
007-RC2005	Bits Tutucu 60mm Bilisterli	12	240	1,95 \$
007-RC2006	Bits Tutucu 75mm Bilisterli	12	240	2,30 \$

1/4" KEYLESS CHUCK

BİTS SAPLI MANDREN BÜYÜK 5 mm

GRV

KOD	ÜRÜN	📦	📦	FİYAT
008-RT4406	Bits Saplı Mandren Büyük 5mm	50	200	6,55 \$

1/4" KEYLESS CHUCK

BİTS SAPLI MANDREN KÜÇÜK 3 mm

GRV

KOD	ÜRÜN	📦	📦	FİYAT
008-RT4407	Bits Saplı Mandren Küçük 3mm	50	200	5,10 \$

**PROFESYONEL
ÇÖZÜM ORTAĞINIZ**

RICO[®]
PROFESSIONAL

BORU ANAHTARLARI



www.rico.com.tr

SWEDISH PIPE WRENCH

MAŞALI BORU ANAHTARI

Dişleri Döndürme Yönüne Ters Yönde Açılmış ve Endüksiyonla Sertleştirilmiş

Ağız Açısını Düzenleyen Hassas Ayar

Komple Sertleştirilmiş Çelik

Yüksek Kalite Chrome Vanadium Çeliğinden Üretilmiş



Made in
Türkiye

KOD	ÜRÜN	📦	📦	FİYAT
002-KK4003	1"	4	24	17,00 \$
002-KK4004	1.5"	1	12	25,00 \$
002-KK4005	2"	1	8	45,00 \$

STILLSON TYPE PIPE WRENCH BLACK

BORU ANAHTARI

Made in
Türkiye

KOD	ÜRÜN	📦	📦	FİYAT
002-KK4010	10"	6	48	16,00 \$
002-KK4012	12"	6	36	21,00 \$
002-KK4014	14"	5	20	26,00 \$

PVC PIPE CUTTER WT 1021 30 MM

BAKIR BORU KESME WT 1021 30 mm

KOD	ÜRÜN	📦	📦	FİYAT
002-KK0623	30 mm	10	120	11,80 \$

PVC PIPE CUTTER WT 1013 40 MM

PVC BORU KESME WT 1013 40 mm

KOD	ÜRÜN	📦	📦	FİYAT
002-KK0624	40 mm	10	40	17,00 \$

PROFESSIONAL ADJUSTABLE WRENCH

PROFESYONEL **KURBAĞACIKLAR**

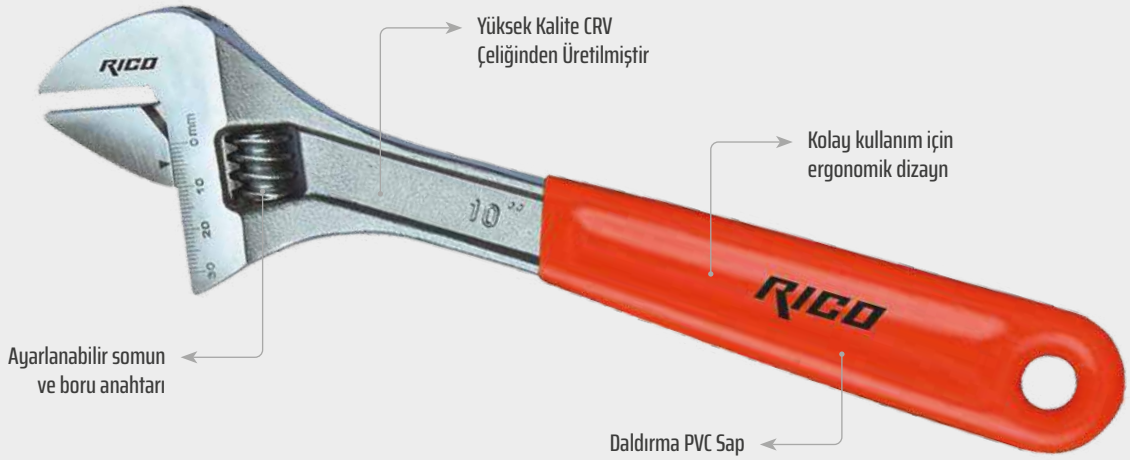

Yüksek Kalite CRV Çeliğinden Üretilmiştir

Kolay kullanım için ergonomik dizayn

Ayarlanabilir somun ve boru anahtarı

Daldırma PVC Sap

PROFESSIONAL ADJUSTABLE WRENCH

PROFESYONEL
KURBAĞACIK



KOD	ÜRÜN	📦	📦	FİYAT
002-RC2014	4" Prof.	6	240	4,80 \$
002-RC2016	6" Prof.	6	120	6,10 \$
002-RC2017	8" Prof.	6	72	9,80 \$
002-RC2018	10" Prof.	6	48	14,30 \$
002-RC2019	12" Prof.	6	24	19,60 \$
002-RC2020	15" Prof.	6	12	36,20 \$

PROFESSIONAL ADJUSTABLE WRENCH

PROFESYONEL İZOLELİ
KURBAĞACIK KROM



KOD	ÜRÜN	📦	📦	FİYAT
002-RC2114	4 Krom	6	120	4,80 \$
002-RC2116	6 Krom	6	120	6,10 \$
002-RC2117	8 Krom	6	72	9,80 \$
002-RC2118	10 Krom	6	48	14,30 \$
002-RC2119	12 Krom	6	24	19,60 \$
002-RC2120	15 Krom	6	12	36,20 \$

PROFESSIONAL ADJUSTABLE WRENCH

PROFESYONEL İZOLELİ
KURBAĞACIK SİYAH



KOD	ÜRÜN	📦	📦	FİYAT
002-RC2216	6 Siyah	6	120	6,10 \$
002-RC2217	8 Siyah	6	72	9,80 \$
002-RC2218	10 Siyah	6	48	14,30 \$
002-RC2219	12 Siyah	6	24	19,60 \$
002-RC2220	15 Siyah	6	12	36,20 \$

**PROFESYONEL
ÇÖZÜM ORTAĞINIZ**

RICO[®]
PROFESSIONAL

KRIKO GRUBU



www.rico.com.tr

PNEUMATIC WINCH
HİDROLİK MOTOR VİNCİ

KOD	ÜRÜN	📦	📦	FİYAT
013-RC6029	Hidrolik Motor Vinci 1 Ton	1	1	310,00 \$
013-RC6030	Hidrolik Motor Vinci 2 Ton	1	1	390,00 \$

HYDRAULIC LIFT
HİDROLİK KRİKO

KOD	ÜRÜN	📦	📦	FİYAT
013-RC6031	Hidrolik Kriko 3 Ton	1	1	225,00 \$

VERTICAL TRANSMISSION JACK

DIKEY ŞANZIMAN KRIKOSU 0.5 TON



Made in
Türkiye

0.5 TON
KALDIRMA KAPASİTESİ



KOD	ÜRÜN	📦	📦	FİYAT
013-RC6023	Dikey Şanzıman Krikosu 0.5 Ton	1	1	225,00 \$

TYRE LEVER PROFESSIONAL TYRE LEVER

PROF LEVYE



Made in
Türkiye



KOD	ÜRÜN	📦	📦	FİYAT
013-RC5080	Prof. Levye 12" (30 cm)	6	48	7,50 \$
013-RC5081	Prof. Levye 16" (40 cm)	6	48	9,25 \$
013-RC5082	Prof. Levye 20" (50 cm)	6	24	11,75 \$
013-RC5083	Prof. Levye 24" (60 cm)	6	24	15,00 \$

BOOTLE JACK

ŞİŞE KRIKOLAR



KOD	ÜRÜN	📦	📦	FİYAT
013-RC6000	Şişe Kriko 2 Ton	1	6	18,70 \$
013-RC6001	Şişe Kriko 3 Ton	1	6	22,00 \$
013-RC6002	Şişe Kriko 5 Ton	1	4	27,50 \$

TYRE LEVER PROFESSIONAL TYRE LEVER

PROF OLUKLU LEVYE



Made in
Türkiye



KOD	ÜRÜN	📦	📦	FİYAT
013-RC5004	Oluklu Levye 24" (60 cm)	6	48	16,25 \$

JACK STAND 6 TON WITH SAFTY PIN

ARABA SEHPASI 6 TON EMNİYET PİMLİ



Made in
Türkiye

KOD	ÜRÜN	📦	📦	FİYAT
013-RC6028	Araba Sehпасı 3 Ton Emniyet Pimli	2	2	46,00 \$
013-RC5999	Araba Sehпасı 6 Ton Emniyet Pimli	2	2	75,00 \$

ELECTRICAL JACK

ELEKTRİKLİ KRIKO 12V



2 TON
KALDIRMA KAPASİTESİ

KOD	ÜRÜN	📦	📦	FİYAT
013-RC6035	Elektrikli Kriko 12V - 2 Ton	1	5	130,00 \$

FULLY AUTOMATIC VEHICLE LIFT

TAM OTOMATİK ARAÇ LİFTİ 4 TON

KOD	ÜRÜN	1	1	FİYAT
025-TA0023	Araç Lifti 4 Ton	1	1	3750,00 \$

ENGINE STAND

MOTOR SEHPASI 680 KG

KOD	ÜRÜN	1	1	FİYAT
013-RC6034	Motor Sehpaı 680 Kg	1	1	165,00 \$

HYDRAULIC RECTIFICATION SET

HİDROLİK DOĞRULTMA TAKIMI 4 TON

KOD	ÜRÜN	3D	2D	FİYAT
013-RC6032	Hidrolik Doğrultma Takımı	1	1	180,00 \$

HYDRAULIC RECTIFICATION SET

HİDROLİK DOĞRULTMA TAKIMI 10 TON

KOD	ÜRÜN	3D	2D	FİYAT
013-RC6033	Hidrolik Doğrultma Takımı	1	1	250,00 \$

**PROFESYONEL
ÇÖZÜM ORTAĞINIZ**

RICO[®]
PROFESSIONAL

OTOMOTİV GRUBU



www.rico.com.tr

CYLINDER PRESSURE METER

KOMPRESYON TEST KİTİ BENZİN

KOD	ÜRÜN	📦	📦	FİYAT
013-KK1120	Kompresyon Test Kiti Benzin	1	10	35,00 \$

CYLINDER PRESSURE METER FOR DIESEL

KOMPRESYON TEST KİTİ DİZEL

KOD	ÜRÜN	📦	📦	FİYAT
013-KK1123	Kompresyon Test Kiti Dizel	1	6	68,00 \$

WATER TANK LEAK DETECTOR

RADYATÖR TEST KİTİ

KOD	ÜRÜN	📦	📦	FİYAT
013-KK1121	Radıyatör Test Kiti	1	5	148,00 \$

INTERCHANGEABLE - FORK SPRING COMPRESSOR

AMORTİSÖR YAYI SÖKME KİTİ

KOD	ÜRÜN	📦	📦	FİYAT
013-KK1122	Amortisör Yayısı Sökme Kiti	1	1	250,00 \$

12PCS SET BRAKE PUSH PIN GRAY

12PC FREN PİSTONU İTME SETİTürkiye
Made in

KOD	ÜRÜN	📦	📦	FİYAT
013-KK1125	12PC Fren Pistonu İtme Seti	1	10	44,00 \$

PNEUMATIC BRAKE CALIPER KIT 16 PCS

HAVALI FREN İTME PİSTONU 16 PARÇA

KOD	ÜRÜN	📦	📦	FİYAT
013-KK1135	Havalı Fren İtme Pistonu	1	6	73,00 \$

110PCS PROFESSIONAL TAP - DIE SET

110 PARÇA PAFTA KILAVUZ SETİ



KOD	ÜRÜN	📦	📦	FİYAT
005-RC3241	110PC Pafta Kılavuz Seti	1	3	152,00 \$

İÇİNDEKİLER

- * Ölçüler: 2x0.4 / 3x0.5 / 4x0.7 / 5x0.8 / 6x0.75 / 6x1.0 / 7x0.75 / 7x1.0 / 8x0.75 / 8x1.0 / 8x1.25 / 9x0.75 / 9x1.0 / 9x1.25 / 10x0.75 / 10x1.0 / 10x1.25 / 10x1.5 / 11x0.75 / 11x1.0 / 11x1.25 / 11x1.5 / 12x0.75 / 12x1.0 / 12x1.25 / 12x1.5 / 12x1.75 / 14x1.0 / 14x1.25 / 14x1.5 / 14x2.0 / 16x1.0 / 16x1.5 / 16x2.0 / 18x1.5
- * 35 Adet Konik Kılavuz * 35 Adet Pafta
- * 2 Adet Kılavuz Kolu * 2 Adet Pafta Kolu
- * 1 Adet Cırcırlı Kılavuz Kolu

6PCS SCREW EXTRACTOR SET

6 PARÇA TERS KILAVUZ SETİ



KOD	ÜRÜN	📦	📦	FİYAT
005-RC3216	6PC Ters Kılavuz Seti	6	100	7,50 \$

İÇİNDEKİLER

- * Ölçüler: 3-6, 6-8, 8-11, 11-14, 14-18, 18-25

131PCS THREAD REPAIR KIT

131PC VİDA TAMİR SETİ



KOD	ÜRÜN	📦	📦	FİYAT
013-KK1124	131PC Vida Tamir Seti	1	10	92,70 \$

40PCS PROFESSIONAL TAP - DIE SET

40 PARÇA PAFTA KILAVUZ SETİ



KOD	ÜRÜN	📦	📦	FİYAT
005-RC3240	40PC Pafta Kılavuz Seti	1	10	35,00 \$

İÇİNDEKİLER

- * Kılavuzlar: M3X0.5, M3X0.6, M4X0.7, M4X0.75, M5X0.8, M5X0.9, M6X0.75, M6X1.0, M7X0.75, M7X1.0, M8X1.0, M8X1.25, M10X1.25, M10X1.5, M12X1.5, M12X1.75, 1/8 NPT27
- * Paftalar: M8X1.28, M8X1.0, M10X1.5, M10X1.25, 1/8NPT27, M5X0.9, M6X1.0, M6X0.75, M7X1.0, M7X0.75, M3X0.5, M3X0.6
- M4X0.7, M4X0.75, M5X0.8, M12X1.75, M12X1.5
- * 1 Adet Kılavuz Kolu * 1 Adet Pafta Kolu * 1 Adet Mini Tornavida * 1 Adet Mini Çakı
- * 1 Adet T Anahtar

UNDER VEHICLE LYING BOARD

ARAÇ ALTI YATMA TAHTASIMade in
Türkiye

KOD	ÜRÜN	📦	📦	FİYAT
025-TA0022	Araç Altı Yatma Tahtası	1	4	38,00 \$

BALL JOINT EXTRACTOR

ROTİL ÇEKTİRMELERMade in
Türkiye

KOD	ÜRÜN	📦	📦	FİYAT
013-RC1020	Rotil Çektirme 18 mm	2	20	17,50 \$
013-RC1021	Rotil Çektirme 23 mm	2	20	25,80 \$
013-RC1022	Rotil Çektirme 29 mm	1	20	33,00 \$
013-RC1023	Rotil Çektirme 40 mm	1	20	44,70 \$
013-RC1024	Rotil Çektirme 50 mm	1	20	56,70 \$

ROT EXTRACTION DEVICE

ROT KOLU SÖKME APARATIMade in
Türkiye

KOD	ÜRÜN	📦	📦	FİYAT
013-RC1078	Rot Kolu Sökme Aparatı	1	8	60,00 \$

COIL SPRING COMPRESSOR

HELEZON YAY ÇEKTİRMELERMade in
Türkiye

KOD	ÜRÜN	📦	📦	FİYAT
013-RC1011	Helezon Yay Çektirme 5/8 270 mm	1	10	42,00 \$
013-RC1010	Helezon Yay Çektirme 5/8 370 mm	1	8	47,00 \$

JAW GEAR PULLER FOR ROTIL

ROTİL ÇEKTİRMEMade in
Türkiye

KOD	ÜRÜN	📦	📦	FİYAT
013-RC1007	Rotil Çektirme	1	20	17,00 \$

MAGNETIC BOWL 1021

MANYETİK TAS 1021



4 WAY CROSS RIM WRENCH CLASSIC

4'LÜ BİJON ANAHTARI KLASİK



Made in
Türkiye

KOD	ÜRÜN	📦	📦	FİYAT
013-RC8555	Manyetik Tas 1021	6	24	9,50 \$

KOD	ÜRÜN	📦	📦	FİYAT
007-RC0122	17-19-21-22 mm	1	15	16,00 \$

L TYPE SPANNER

PİPO TİP BİJON ANAHTARLARI



Made in
Türkiye

EXTENDABLE LUG WRENCH

LOKMALI L BİJON KOL



KOD	ÜRÜN	📦	📦	FİYAT
013-RC5084	Pipo Tip Bijon Anahtarı 17 mm	1	35	7,00 \$
013-RC5079	Pipo Tip Bijon Anahtarı 19 mm	1	50	7,50 \$
013-RC5085	Pipo Tip Bijon Anahtarı 21 mm	1	50	8,00 \$
013-RC5086	Pipo Tip Bijon Anahtarı 22 mm	1	50	8,50 \$
013-RC5087	Pipo Tip Bijon Anahtarı 23 mm	1	50	9,10 \$
013-RC5088	Pipo Tip Bijon Anahtarı 24 mm	1	50	9,60 \$

KOD	ÜRÜN	📦	📦	FİYAT
007-RC0121	Lokmalı L Bijon Kol LG002	1	20	14,00 \$

Z BAR 8x10MM

Z TİP TAPA ANAHTAR 8x10mm



Made in
Türkiye **GRV**

GAUGE WRENCH OF WALF

SUBAP AYAR ANAHTARI



Made in
Türkiye

KOD	ÜRÜN	📦	📦	FİYAT
013-RC0013	Z Tip Tapa Anahtar 8x10mm	6	48	7,50 \$

KOD	ÜRÜN	📦	📦	FİYAT
022-RC0004	Subap Ayar Anahtarı	6	60	11,00 \$

CLAMP

KURT AĞZI

KOD	ÜRÜN	📦	📦	FİYAT
013-RC3004	Kurt Ağız İki Yönlü	2	8	50,00 \$



CLAMP

KURT AĞZI

KOD	ÜRÜN	📦	📦	FİYAT
013-RC3005	Kurt Ağızı Tek Yönlü	2	8	45,00 \$



CLAMP

KURT AĞZI

KOD	ÜRÜN	📦	📦	FİYAT
013-RC3006	Kurt Ağızı Yassı Tip	1	8	58,00 \$



CLAMP

KURT AĞZI

KOD	ÜRÜN	📦	📦	FİYAT
013-RC3007	Kurt Ağızı Lamalı	1	8	63,00 \$



2 WAYS JAW GEAR PULLER
RAYLI ÇEKTİRMELER

 Made in
Türkiye
3 WAYS UNIVERSAL PULLER
3 AYAK ÇEKTİRME

 Made in
Türkiye

KOD	ÜRÜN	📦	📦	FİYAT
013-RC80100	Raylı Çektirme 80x100	1	20	27,50 \$
013-RC120100	Raylı Çektirme 120x100	1	16	33,00 \$
013-RC120150	Raylı Çektirme 120x150	1	6	50,00 \$
013-RC200150	Raylı Çektirme 150x200	1	6	63,00 \$
013-RC250200	Raylı Çektirme 250x200	1	3	97,00 \$
013-RC350200	Raylı Çektirme 350x200	1	3	135,00 \$

KOD	ÜRÜN	📦	📦	FİYAT
013-RC0048	3 Ayak Çektirme 12x12	1	1	40,00 \$
013-RC0049	3 Ayak Çektirme 16x16	1	1	60,00 \$
013-RC0050	3 Ayak Çektirme 23x20	1	1	75,00 \$

3 WAYS MASTER PULLER
3 AYAKLI MİNİ ÇEKTİRMELER

 Made in
Türkiye
3 WAYS UNIVERSAL PULLER
3 AYAKLI MİNİ ÇEKTİRMELER

 Made in
Türkiye

KOD	ÜRÜN	📦	📦	FİYAT
013-RC2009	R23-1 60x50 3 Ayak Mini Çektirme	1	48	11,35 \$
013-RC2010	R23-2 70x70 3 Ayak Mini Çektirme	1	48	12,65 \$
013-RC2011	R23-3 80x80 3 Ayak Mini Çektirme	1	48	14,00 \$

KOD	ÜRÜN	📦	📦	FİYAT
013-RC2006	R33-0 60x40 3 Ayak Mini Çektirme	1	48	10,35 \$
013-RC2007	R33-1 65x65 3 Ayak Mini Çektirme	1	48	11,50 \$
013-RC2008	R33-2 80x80 3 Ayak Mini Çektirme	1	48	12,70 \$

2 WAYS PULLER
2 AYAKLI MİNİ ÇEKTİRMELER

 Made in
Türkiye
2 WAYS MASTER PULLER
2 AYAKLI MİNİ ÇEKTİRMELER

 Made in
Türkiye

KOD	ÜRÜN	📦	📦	FİYAT
013-RC2000	R22-0 60x40 2 Ayak Mini Çektirme	1	84	9,30 \$
013-RC2001	R22-1 65x65 2 Ayak Mini Çektirme	1	84	10,40 \$
013-RC2002	R22-2 80x80 2 Ayak Mini Çektirme	1	84	11,50 \$

KOD	ÜRÜN	📦	📦	FİYAT
013-RC2003	R12-1 60x50 2 Ayaklı Mini Çektirme	1	84	10,20 \$
013-RC2004	R12-2 70x70 2 Ayaklı Mini Çektirme	1	84	11,40 \$
013-RC2005	R12-3 80x80 2 Ayaklı Mini Çektirme	1	84	12,65 \$

ARM FOR 2 WAY PULLER

RAYLI ÇEKTİRME KOLU

Türkiye Made in

KOD	ÜRÜN	📦	📦	FİYAT
013-RC7300	Raylı Çektirme Kolu 80 x 100	1	1	6,40 \$
013-RC7301	Raylı Çektirme Kolu 120 x 100	1	1	6,40 \$
013-RC7302	Raylı Çektirme Kolu 120 x 150	1	1	11,65 \$
013-RC7303	Raylı Çektirme Kolu 150 x 200	1	1	11,65 \$
013-RC7304	Raylı Çektirme Kolu 250 x 200	1	1	19,70 \$
013-RC7305	Raylı Çektirme Kolu 350 x 200	1	1	19,70 \$

ARM FOR 3 WAY PULLER

ÇEKTİRME KOLU

Türkiye Made in

KOD	ÜRÜN	📦	📦	FİYAT
013-RC7318	Çektirme Kolu 12 x 12	1	1	7,20 \$
013-RC7319	Çektirme Kolu 16 x 16	1	1	9,10 \$
013-RC7320	Çektirme Kolu 23 x 20	1	1	13,00 \$

SPINDLE

RAYLI ÇEKTİRME MİLİ

Türkiye Made in

KOD	ÜRÜN	📦	📦	FİYAT
013-RC7306	Raylı Çektirme Mili 80 x 100	1	1	6,05 \$
013-RC7307	Raylı Çektirme Mili 120 x 100	1	1	6,05 \$
013-RC7308	Raylı Çektirme Mili 120 x 150	1	1	11,50 \$
013-RC7309	Raylı Çektirme Mili 150 x 200	1	1	11,50 \$
013-RC7310	Raylı Çektirme Mili 250 x 200	1	1	15,20 \$
013-RC7311	Raylı Çektirme Mili 350 x 200	1	1	15,20 \$
013-RC7321	3 Ayak Çektirme Mili 12x12	1	1	6,50 \$
013-RC7322	3 Ayak Çektirme Mili 16x16	1	1	8,60 \$
013-RC7323	3 Ayak Çektirme Mili 23x20	1	1	10,60 \$

CONNECTION PART

BAĞLANTI KELEPÇESİ

Türkiye Made in

KOD	ÜRÜN	📦	📦	FİYAT
013-RC7312	Bağlantı Kelepçesi 80x100	1	1	3,30 \$
013-RC7313	Bağlantı Kelepçesi 120x100	1	1	3,30 \$
013-RC7314	Bağlantı Kelepçesi 120x150	1	1	5,75 \$
013-RC7315	Bağlantı Kelepçesi 150x200	1	1	5,75 \$
013-RC7316	Bağlantı Kelepçesi 250x200	1	1	10,20 \$
013-RC7317	Bağlantı Kelepçesi 350x200	1	1	10,20 \$

PISTON RING COMPRESSOR

PİSTON SEGMAN ÇEMBERİ

KOD	ÜRÜN	📦	📦	FİYAT
013-RC0001	Piston Segman Çemberi 3"	1	60	13,16 \$
013-RC0002	Piston Segman Çemberi 4"	1	60	16,33 \$
013-RC0003	Piston Segman Çemberi 6"	1	60	28,75 \$



TOOL CAR

TEK ÇEKMECELİ TAKIM ARABASI



Made in
Türkiye

TOOL CAR

İKİ ÇEKMECELİ TAKIM ARABASI



Made in
Türkiye

KOD	ÜRÜN	📦	📦	FİYAT
013-RC5998	Tek Çekmeceli Takım Arabası	1	1	84,50 \$

ÜRÜN ÖZELLİKLERİ

- * Uygun Çalışma Alanı Sağlayan Geniş Üst Bölüm
- * En: 400mm Genişlik: 600mm Yükseklik: 800mm

KOD	ÜRÜN	📦	📦	FİYAT
013-RC5997	İki Çekmeceli Takım Arabası	1	1	95,00 \$

ÜRÜN ÖZELLİKLERİ

- * Uygun Çalışma Alanı Sağlayan Geniş Üst Bölüm
- * En: 400mm Genişlik: 600mm Yükseklik: 800mm

TOOL CAR

ÇEKMECESİZ TAKIM ARABASI



Made in
Türkiye

TOOL CAR

5 ÇEKMECELİ TAKIM ARABASI



Made in
Türkiye

KOD	ÜRÜN	📦	📦	FİYAT
013-RC5996	Çekmecesiz Takım Arabası	1	1	77,00 \$

ÜRÜN ÖZELLİKLERİ

- * Uygun Çalışma Alanı Sağlayan Geniş Üst Bölüm
- * En: 400mm Genişlik: 600mm Yükseklik: 800mm

KOD	ÜRÜN	📦	📦	FİYAT
025-TA0005	5 Çekmeceli Takım Arabası	1	1	225,00 \$
025-TA0025	6 Çekmeceli Takım Arabası	1	1	242,00 \$



PROFESSIONAL TOOL CAR

185
PARÇA

5 ÇEKMECELİ DOLU TAKIM ARABASI

KOD	ÜRÜN	📦	📦	FİYAT
025-TA0016	5 Çekmeceli - Dolu	1	1	1055,00 \$

1. ÇEKMECE

- *13PC 1/4" Dr.6 Köşe Lokma: 4, 4.5, 5, 5.5, 6, 7, 8, 9, 10, 11, 12, 13, 14mm
- *8PC 1/4" 6 Köşe Derin Lokma: 6, 7, 8, 9, 10, 11, 12, 13mm
- *18PC 1/4" Bits Lokma (37mmL):
SL4, SL5.5, SL6.5, PH1, PH2, PZ1, PZ2,
H3, H4, H5, H6, T8, T10, T15, T20, T25, T27, T30
- *7PC 1/4" E Lokma: E4, E5, E6, E7, E8, E10, E11
- *17PC 1/2" 6 Köşe Lokma:
10, 11, 12, 13, 14, 15, 16, 17, 18, 19, 20, 21, 22, 24, 27, 30, 32mm
- *7PC 1/2" 6 Köşe Derin Lokma: 10, 13, 14, 15, 17, 19, 22mm
- *8PC 1/2" Delikli Torx Lokma (55mmL):
T20H, T25H, T27H, T30H, T35H, T40H, T45H, T50H (Kalınlık: 10mm)
- *2 PC 1/2" Buji Lokma: 16 & 21mm *1 PC 1/4" 90T Diş Cırcır Kolu
- *1 PC 1/2" 90T Diş Cırcır Kolu *2 PC 1/4" Uzatma, 50mm & 100mmL
- *2 PC 1/2" Uzatma, 125mm & 250mmL
- *1 PC 1/4" Oynar Mafsals *1 PC 1/2" Oynar Mafsals
- *1 PC 1/4" T-Kol, 115mmL *1 PC 1/4" Lokma Tutucu Adaptör, 150mmL
- *1 PC 1/4" Flex Uzatma, 150mmL *1 PC 3/8" 1/2" 3 lü Adaptör
- *1 PC 1/2" Bits Tutucu, 10mm
- *17PC Bits 10mm x 30mmL:
SL8, SL10, SL12; T40, T45, T50, T55, T60, PH3, PH4, PZ3, PZ4, H7, H8, H10, H12, H14

2. ÇEKMECE

- * Yıldız Ekstra Anahtar 8 PC: 6x7, 8x9, 10x11, 12x13, 14x15, 16x17, 18x19, 20x22
- * Kombine Ekstra Anahtar 13 PC: 6, 7, 8, 9, 10, 11, 12, 13, 14, 17, 19, 22, 23mm
- * Açık Ekstra Anahtar 12 PC:
6x7, 8x9, 10x11, 12x13, 14x15, 16x17, 18x19, 20x22, 21x23, 24x27, 25x28, 30x32

3. ÇEKMECE

- * 4PC Klasik Tornavida Düz: 3x75mm, 5x100mm, 6x125mm, 6x150mm
- * 3PC Klasik Tornavida Yıldız: 3x75mm, 5x100mm, 6x100mm
- * 5PC Lokma Tornavida: 6, 7, 8, 10, 13mm
- * 6PC Torx Tornavida: T10, T15, T20, T25, T30, T40

4. ÇEKMECE

- * 9 Pç Düz Kısa Allen: 1,5, 2, 2,5, 3, 4, 5, 6, 8, 10mm
- * Ayarlı Pense 10" * Kelepçe Pensesi Crom
- * Sekman Pensesi Düz İç 7" * Sekman Pensesi Düz Dış 7"
- * Sekman Pensesi Eğri İç 7" * Sekman Pensesi Eğri Dış 7"
- * Steel Pense 7 * Steel Yan Keski 6
- * Steel Kargaburun 6 * Sentil
- * Ağaç Saplı Çekiç 500gr



PROFESSIONAL TOOL CAR
285 PARÇA 6 ÇEKMECELİ DOLU TAKIM ARABASI

KOD	ÜRÜN			FİYAT
025-TA0024	6 Çekmeceli - Dolu	1	1	1300,00 \$

1.ÇEKMECE

- *13PC 1/4" Dr.6 Köşe Lokma: 4, 4.5, 5, 5.5, 6, 7, 8, 9, 10, 11, 12, 13, 14mm
- *8PC 1/4" 6 Köşe Derin Lokma: 6, 7, 8, 9, 10, 11, 12, 13mm
- *18PC 1/4" Bits Lokma (37mmL): SL4, SL5.5, SL6.5, PH1, PH2, PZ1, PZ2, H3, H4, H5, H6, T8, T10, T15, T20, T25, T27, T30
- *7PC 1/4" E Lokma: E4, E5, E6, E7, E8, E10, E11
- *17PC 1/2" 6 Köşe Lokma: 10, 11, 12, 13, 14, 15, 16, 17, 18, 19, 20, 21, 22, 24, 27, 30, 32mm
- *7PC 1/2" 6 Köşe Derin Lokma: 10, 13, 14, 15, 17, 19, 22mm
- *8PC 1/2" Delikli Torx Lokma (55mmL): T20H, T25H, T27H, T30H, T35H, T40H, T45H, T50H (Kalınlık: 10mm)
- *2 PC 1/2" Buji Lokma: 16 & 21mm *1 PC 1/4" 90T Diş Cırcır Kolu
- *1 PC 1/2" 90T Diş Cırcır Kolu *2 PC 1/4" Uzatma, 50mm & 100mmL
- *2 PC 1/2" Uzatma, 125mm & 250mmL
- *1 PC 1/4" Oynar Mafsals *1 PC 1/2" Oynar Mafsals
- *1 PC 1/4" T-Kol, 115mmL *1 PC 1/4" Lokma Tutucu Adaptör, 150mmL
- *1 PC 1/4" Flex Uzatma, 150mmL *1 PC 3/8" 1/2" 3 lü Adaptör
- *1 PC 1/2" Bits Tutucu, 10mm
- *17PC Bits 10mm x 30mmL: SL8, SL10, SL12; T40, T45, T50, T55, T60, PH3, PH4, PZ3, PZ4, H7, H8, H10, H12, H14

2.ÇEKMECE

- * Yıldız Ekstra Anahtar 8 PC: 6x7, 8x9, 10x11, 12x13, 14x15, 16x17, 18x19, 20x22
- * Kombine Ekstra Anahtar 13 PC: 6, 7, 8, 9, 10, 11, 12, 13, 14, 17, 19, 22, 23mm
- * Açık Ekstra Anahtar 12 PC: 6x7, 8x9, 10x11, 12x13, 14x15, 16x17, 18x19, 20x22, 21x23, 24x27, 25x28, 30x32
- * 1 PC Şarjlı Led El Lambası: 240 Lm

3.ÇEKMECE

- * 4PC Kraft Tornavida Düz: 3x75mm, 5x100mm, 6x125mm, 6x150mm
- * 3PC Kraft Tornavida Yıldız: 3x75mm, 5x100mm, 6x100mm
- * 5PC Lokma Tornavida: 6, 7, 8, 10, 13mm
- * 6PC Torx Star Tornavida: T10, T15, T20, T25, T30, T40
- * 1PC Darbeli Düz Tornavida: 9.5x250mm

4.ÇEKMECE

- * 9 Pc Düz Kısa Allen: 1,5, 2, 2,5, 3, 4, 5, 6, 8, 10mm
- * Ayarlı Pense 10" * Keleçe Pensesi Crom
- * Sekman Pensesi Düz İç 7" * Sekman Pensesi Düz Dış 7"
- * Sekman Pensesi Eğri İç 7" * Sekman Pensesi Eğri Dış 7"
- * Craft Pense 7 * Craft Yan Keski 6
- * Craft Kargaburun 6 * Sentil
- * Ağaç Saplı Çekiç 500gr

5.ÇEKMECE

- * 40 Pc Kaplamalı Bits Set
- * 29 Pc Şeffaf Bits Set Deliksiz
- * 9 Pc 1/2 İç Torx E Lokma Seti Kısa
- * 6 Pc Pim Sökme Düz
- * 4 Pc Conta ve Oring Çıkartma Seti
- * 3 Pc 1/2 6 Köşe Derin Havalı Lokma: 17,19,21mm
- * 2 Pc Klasik Topaç Tornavida 6x38 Düz, 6x38 Yıldız
- * 1 Pc Craft Fort Pense Döğmeli
- * 1 Pc Miknatıslı Anten 1.5 Lbs
- * 1 Pc Düz Keski 200mm
- * 1 Pc Oto Kontrol Kalemli Metal-Düz Kablolü

25PCS SCREW THREAD SET

VİDA TAMİR SETİ YAYI M12* 1.75 - 1.5D

KOD	ÜRÜN	📦	📦	FİYAT
013-KK1129	Vida Tamir Seti YayI M12* 1.75 - 1.5D	1	30	9,80 \$

25PCS SCREW THREAD SET

VİDA TAMİR SETİ YAYI M10* 1.5 - 1.5D

KOD	ÜRÜN	📦	📦	FİYAT
013-KK1128	Vida Tamir Seti YayI M10* 1.5 - 1.5D	1	30	8,00 \$

25PCS SCREW THREAD SET

VİDA TAMİR SETİ YAYI M8* 1.25 - 1.5D

KOD	ÜRÜN	📦	📦	FİYAT
013-KK1127	Vida Tamir Seti YayI M8* 1.25 - 1.5D	1	50	7,45 \$

25PCS SCREW THREAD SET

VİDA TAMİR SETİ YAYI M5* 0.8 - 1.5D

KOD	ÜRÜN	📦	📦	FİYAT
013-KK1126	Vida Tamir Seti YayI M5* 0.8 - 1.5D	1	50	5,10 \$

5PCS COMPOSITE TRIM REMOVAL TOOL SET

PVC DÖŞEME VE TRİM SÖKME TAKIMI

KOD	ÜRÜN	📦	📦	FİYAT
013-RC1301	PVC Döşeme ve Trim Sökme Takımı	6	24	11,04 \$

CLIP REMOVAL

KLİPS SÖKME

KOD	ÜRÜN	📦	📦	FİYAT
013-KK0161	Klips Sökme	6	96	5,25 \$
013-KK0162	Klips Sökme 6x158	6	96	3,00 \$
013-KK0163	Klips Sökme 8x182	6	96	3,85 \$

GREASE PUMP APPARATUS
GRES POMPASI APARATLARI

GREASE GUN 500 CC
GRES POMPASI 500CC

KOD	ÜRÜN	📦	📦	FİYAT
013-RC0172	Gres Pompası Metal Bağlantı Borusu	10	200	1,72 \$
013-RC0173	Gres Pompası Kauçuk Bağlantı Borusu	10	200	2,41 \$
013-RC0174	Gres Pompası Metal Bağlantı Ucu	10	200	1,32 \$

KOD	ÜRÜN	📦	📦	FİYAT
013-RC0168	Gres Pompası 500cc	1	20	17,00 \$

BOTTLE SPIRAL OIL POT
YAĞDANLIK

Türkiye Made in

BOTTLE SPIRAL OIL POT
YAĞDANLIK

Türkiye Made in

KOD	ÜRÜN	📦	📦	FİYAT
013-RC0162	Yağdanlık 400 cc Spiralli	10	100	4,40 \$

KOD	ÜRÜN	📦	📦	FİYAT
013-RC0171	Yağdanlık 400 cc Metal Uçlu	10	100	4,40 \$

FOAM GUN
KÖPÜK TABANCASI

WASHING GUN
MAZOT PÜSKÜRTME TABANCASI

KOD	ÜRÜN	📦	📦	FİYAT
013-RC0053	Köpük Tabancası	10	50	11,50 \$

KOD	ÜRÜN	📦	📦	FİYAT
013-RC0004	Mazot Püskürtme Tabancası	2	20	10,00 \$

3 WAY OIL FILTER WRENCH

3 AYAKLI FİLTRE ANAHTARI EĞRİ



Made in
Türkiye

KOD	ÜRÜN	📦	📦	FİYAT
013-KK1106	3 Ayak Filtre Anahtarı Eğri R-01	1	36	12,00 \$

1/2" - 3/8" OIL FILTER CUP WRENCH

TAS TİPİ FİLTRE SÖKME METAL



Made in
Türkiye

KOD	ÜRÜN	📦	📦	FİYAT
013-KK1224	1/2" Tas Tipi Filtre 76/12 (Clio, Megan, Kangoo)	10	100	7,80 \$
013-KK1225	1/2" Tas Tipi Filtre 76/14 (Volkswagen, Skoda, Audi, Seat)	10	100	7,80 \$
013-KK1226	1/2" Tas Tipi Filtre 76/15 (Ford Grubu, Focus, Fiesta Benzinli)	10	100	7,80 \$
013-KK1227	1/2" Tas Tipi Filtre 66/6 (Renault, Clio 1.2 Benzinli)	10	100	7,80 \$
013-KK1228	1/2" Tas Tipi Filtre 65/14 (Toyota, Honda Benzinli)	10	100	7,80 \$
013-KK1229	1/2" Tas Tipi Filtre 74/15 (Opel 1.6 Benzinli)	10	100	7,80 \$
013-KK1230	1/2" Tas Tipi Filtre 67/14 (Nissan Grubu, Almera, Primera Benzinli)	10	100	7,80 \$
013-KK1231	1/2" Tas Tipi Filtre (Toyota Benzinli)	10	100	16,00 \$
013-KK1232	1/2" Tas Tipi Filtre (Toyota Dizel)	10	100	16,00 \$

ÜRÜN ÖZELLİKLERİ

76/12: Renault, Ford, Peugeot 76/14: Mercedes, Bmw, Audi, VW, Seat, Porsche
65/14: Honda, Toyota, Japon Arabaları 66/6: Fiat Marka Araçlar

12PCS SET OIL FILTER CUP WRENCH

12PC TAS FİLTRE SÖKME SETİ

Made in
Türkiye **GRV**

KOD	ÜRÜN	📦	📦	FİYAT
013-KK1233	12PC Tas Filtre Sökme Seti	1	5	115,00 \$

İÇİNDEKİLER

65mm x 14, 80mm x 15, 73mm x 14, 93mm x 15, 76mm x 30, 75/77mm x 15, 68mm x 14, 90mm x 15, 76mm x 14, 100mm x 15, 65/67mm x 14, 80/82mm x 15, 74/76mm x 15, 93mm x 36, 3/8" ADAPTÖR

3 WAY OIL FILTER WRENCH

3 AYAKLI FİLTRE ANAHTARI DÜZ



Made in
Türkiye

KOD	ÜRÜN	📦	📦	FİYAT
013-KK1101	3 Ayak Filtre Anahtarı Düz	1	36	12,00 \$

1/2" OIL FILTER CUP WRENCH

TAS TİPİ FİLTRE SÖKME PROF.



Made in
Türkiye

KOD	ÜRÜN	📦	📦	FİYAT
013-KK1217	1/2" Tas Tipi Filtre 66/14 (Nissan)	10	100	9,75 \$
013-KK1218	1/2" Tas Tipi Filtre 66/6 (Renault, Fiat)	10	100	9,75 \$
013-KK1219	1/2" Tas Tipi Filtre 65/14 (Toyota)	10	100	9,75 \$
013-KK1221	1/2" Tas Tipi Filtre 76/15 (Ford Transit)	10	100	10,25 \$
013-KK1223	1/2" Tas Tipi Filtre 88/16 (BMW, M Grubu)	10	100	10,25 \$

ÜRÜN ÖZELLİKLERİ

65/14: Honda, Toyota, Japon Arabaları
66/14: Nissan
66/6: Renault, Fiat
76/15: Ford Transit
88/16: BMW M Grubu



BELT WRENCH 9"

KEMERLİ FİLTRE ANAHTARI 9"



Made in
Türkiye

KOD	ÜRÜN	📦	📦	FİYAT
013-KK1117	Kemerli Filtre Anahtarı 9"	6	60	10,00 \$

BELT WRENCH 12"

KEMERLİ FİLTRE ANAHTARI 12"



Made in
Türkiye

KOD	ÜRÜN	📦	📦	FİYAT
013-KK1118	Kemerli Filtre Anahtarı 12"	6	30	16,00 \$

CHAIN WRENCH 9"

ZİNCİRLİ FİLTRE ANAHTARI 9"



Made in
Türkiye

KOD	ÜRÜN	📦	📦	FİYAT
013-KK1104	Zincirli Filtre Anahtarı 9"	6	48	10,00 \$

CHAIN WRENCH 12"

ZİNCİRLİ FİLTRE ANAHTARI 12"



Made in
Türkiye

KOD	ÜRÜN	📦	📦	FİYAT
013-KK1108	Zincirli Filtre Anahtarı 12"	6	36	22,00 \$

ENGINE HANGER

MOTOR ASKILIK AĞIR TİP



Made in
Türkiye

KOD	ÜRÜN	📦	📦	FİYAT
013-RC1089	Motor Askılık Ağır Tip 150cm	1	1	105,00 \$
013-RC1390	Motor Askılık Ağır Tip 170cm	1	1	115,00 \$

PROF. LONG NOSE PLIER CROM HANDLE

KELEPÇE PENSESİ KROM SAPLIMade in
Türkiye

KOD	ÜRÜN	📦	📦	FİYAT
001-RC0871	Kelepçe Pensesi Krom	6	60	14,00 \$

HOSE CLAMP CLIPPER

HORTUM KELEPÇE KERPETENİ

KOD	ÜRÜN	📦	📦	FİYAT
001-RC5012	Hortum Kelepçe Kerpeteni	6	72	8,00 \$

TUBE BLOCKING PLIERS ORANGE HANDLE

KELEPÇE PENSESİ YENİ TİP

KOD	ÜRÜN	📦	📦	FİYAT
001-RC0872	Kelepçe Pensesi Yeni Tip	6	72	13,25 \$

BOLT CUTTER 8"

KUBLON MAKASI

KOD	ÜRÜN	📦	📦	FİYAT
021-KK2308	Kublon Makası 8"	6	60	10,00 \$

BOLT CUTTER 8"

PROF. MİNİ KUBLON MAKASI

KOD	ÜRÜN	📦	📦	FİYAT
021-KK2307	Prof. Mini Kublon Makası 8"	6	36	17,00 \$

TIN SNIP- BENT
KUYUMCU MAKASI EĞRİ

KOD	ÜRÜN	📦	📦	FİYAT
025-KK4401	Kuyumcu Makası Eğri	6	120	5,00 \$

ÜRÜN ÖZELLİKLERİ

- Yüksek Kalite Kesici Alet Çeliğinden Üretilmiştir.
- Daldırma PVC Sap
- Hassas Kesici Ağzlar

TIN SNIP-STRAIGHT
KUYUMCU MAKASI DÜZ

KOD	ÜRÜN	📦	📦	FİYAT
025-KK4400	Kuyumcu Makası Düz	6	120	5,00 \$

ÜRÜN ÖZELLİKLERİ

- Yüksek Kalite Kesici Alet Çeliğinden Üretilmiştir.
- Daldırma PVC Sap
- Hassas Kesici Ağzlar

TIN SNIP DROP FORGED
TENEKECİ MAKASI DÖVME ÇELİK

 Made in
Türkiye

KOD	ÜRÜN	📦	📦	FİYAT
025-RT0013	Tenekeci Makası Dövme Çelik	6	60	8,00 \$

ÜRÜN ÖZELLİKLERİ

- Yüksek Kalite Kesici Alet Çeliğinden Üretilmiştir.
- Daldırma PVC Sap
- Hassas Kesici Ağzlar

OIL FILTER PLIER
YAĞ FİLTRE SÖKME PENSESİ

 Made in
Türkiye

KOD	ÜRÜN	📦	📦	FİYAT
013-KK6090	Yağ Filtre Sökme Pensesi 60-90mm	6	48	12,00 \$
013-KK6091	Yağ Filtre Sökme Pensesi 115-287mm	6	48	15,00 \$

ADJUSTABLE OIL FILTER WRENCH 95 - 111 MM
AYARLI YAĞ FİLTRE ANAHTARI 95-111 mm

KOD	ÜRÜN	📦	📦	FİYAT
013-KK1119	Ayarlı Yağ Filtre Anahtarı 95-111 mm	6	36	16,10 \$

INSPECTION MIRROR & PICK-UP TOOL
2-IN-1 ANTEN AYNA BÜYÜK

KOD	ÜRÜN	📦	📦	FİYAT
013-RC8137	2-in-1 Anten Ayna Büyük	12	120	7,00 \$

ADJUSTABLE OIL FILTER WRENCH

VİDALI FİLTRE ANAHTARI

Made in
Türkiye

KOD	ÜRÜN	📦	📦	FİYAT
013-KK0159	Vidalı Filtre Anahtarı	1	50	11,20 \$

FILTER CYCLE

FİLTRE ÇEMBERİ

Made in
Türkiye

KOD	ÜRÜN	📦	📦	FİYAT
013-KK0160	Filtre Çemberi	25	50	0,90 \$

4 PIECE ORING REMOVAL SET

4 PARÇA ORİNG SÖKME SETİ

Made in
Türkiye

KOD	ÜRÜN	📦	📦	FİYAT
003-KK1973	4 Parça Oring Sökme Seti	25	100	5,25 \$

MAGNETIC TOOL

MIKNATIS ANTEN 1.5 KG

Made in
Türkiye

KOD	ÜRÜN	📦	📦	FİYAT
013-RC8552	Mıknatıs Anten 1.5 Kg	25	100	6,30 \$

SPIRAL MAGNET 3 KG

SİRALLİ MIKNATIS 3 KG

Made in
Türkiye

KOD	ÜRÜN	📦	📦	FİYAT
013-RC4007	Spiralli Mıknatıs 3 Kg	12	120	12,50 \$

SPIRAL LIGHT MAGNET

SİRALLİ IŞIKLI MIKNATIS



KOD	ÜRÜN	📦	📦	FİYAT
013-RC4008	Işıklı Spiralli Makinist Parmağı	12	120	12,00 \$

PROFESSIONAL ANTIFREEZE BOOM

**PROFESYONEL
ANTİFRİZ BOMESİ**



ANTI-FREEZE TESTER

ANTİFRİZ BOMESİ



KOD	ÜRÜN	1	100	FİYAT
013-RC6027	Profesyonel Antifriz Bomesi	1	100	20,00 €

KOD	ÜRÜN	10	100	FİYAT
013-RC6021	Antifriz Bomesi	10	100	5,40 \$

FEELER GAUGE

FEELER ÇAKI-SENTİL



BATTERY TESTER

AKÜ BOMESİ



KOD	ÜRÜN	12	120	FİYAT
013-RC0163	Feeler Çakı-Sentil	12	120	6,00 \$

KOD	ÜRÜN	10	100	FİYAT
013-RC6022	Akü Bomesi	10	100	5,40 \$

FLOAT REMOVER SWITCH

ŞAMANDIRA SÖKME ANAHTARI



Made in
Türkiye

KOD	ÜRÜN	1	1	FİYAT
013-KK1133	Şamandıra Sökme Anahtarı	1	1	12,00 \$

LED WORK AND FLASH LIGHT

ŞARJLI EL LAMBASI LEDLİ K16 240LM**ÜRÜN ÖZELLİKLERİ**

- USB Şarj
- 8 Saat Kesintisiz Işık
- 240lm Aydınlatma Gücü
- 180 Derece Açılır Ayak
- Mıknatısla Sabitleme



KOD	ÜRÜN	☐	☒	FİYAT
013-RC0037	K16 240Lm	6	24	35,25 \$

LED WORK AND FLASH LIGHT

ŞARJLI EL LAMBASI LEDLİ K19 420LM**ÜRÜN ÖZELLİKLERİ**

- USB Şarj
- 8 Saat Kesintisiz Işık
- 420lm Aydınlatma Gücü
- 180 Derece Açılır Ayak
- Mıknatısla Sabitleme



KOD	ÜRÜN	☐	☒	FİYAT
013-RC0038	K19 420Lm	6	24	37,00 \$

LED RECHARGEABLE LIGHT

LED ŞARJLI FENER XX307C

KOD	ÜRÜN	☐	☒	FİYAT
013-RC0022	Led Şarjlı Fener XX307C	1	10	35,00 \$

LED RECHARGEABLE LIGHT

LED ŞARJLI FENER XX307B

KOD	ÜRÜN	☐	☒	FİYAT
013-RC0021	Led Şarjlı Fener XX307B	2	8	35,00 \$

LED RECHARGEABLE LIGHT

LED ŞARJLI FENER XX305C

KOD	ÜRÜN	☐	☒	FİYAT
013-RC0020	Led Şarjlı Fener XX305C	1	10	35,00 \$

LED RECHARGEABLE LIGHT

LED PİLLİ FENER XX202

KOD	ÜRÜN	☐	☒	FİYAT
013-RC0026	Led Pili Fener XX202	6	24	9,00 \$

LED WORK AND FLASH LIGHT

ŞARJLI EL LAMBASI LEDLİ 600LM

• UV Lamba Özelliği



ÜRÜN ÖZELLİKLERİ

- 180° Döner Başlık
- Şarj Standı
- 600lm Aydınlatma Gücü
- Şarj Göstergesi
- Miknatısla Sabitleme
- Kırmızı Reflektör Işık



KOD	ÜRÜN	6	24	FİYAT
013 - RC0027	600Lm			40,00 \$

LED WORK AND FLASH LIGHT

MİNİ ŞARJLI EL LAMBASI LEDLİ 300LM



ÜRÜN ÖZELLİKLERİ

- 180° Döner Başlık
- Şarj Standı
- 600lm Aydınlatma Gücü
- Şarj Göstergesi
- Miknatısla Sabitleme
- Kırmızı Reflektör Işık



KOD	ÜRÜN	6	24	FİYAT
013 - RC0032	300Lm			15,00 \$

LED WORK AND FLASH LIGHT

ŞARJLI EL LAMBASI LEDLİ 600LM



ÜRÜN ÖZELLİKLERİ

- 3.7V 4000 mAh
- Şarj USB - C
- 600lm Aydınlatma Gücü
- Şarj Göstergesi
- Miknatısla Sabitleme
- Kırmızı Reflektör Işık
- Mavi UV Lamba



KOD	ÜRÜN	6	24	FİYAT
013 - RC0031	600Lm			37,00 \$

LED WORK AND FLASH LIGHT

ŞARJLI KALEM IŞIK LEDLİ 300LM



KOD	ÜRÜN	6	24	FİYAT
013 - RC0033	300Lm			21,00 \$

LED WORK AND FLASH LIGHT

ŞARJLI KALEM IŞIK LEDLİ 250LM



KOD	ÜRÜN	6	24	FİYAT
013 - RC0034	250Lm			17,00 \$

ŞARJLI EL LAMBASI LEDLİ 7000LM

KOD	ÜRÜN	3D	2D	FİYAT
013 - RC0039	Tripod Çalışma Lambası	6	24	106,00 \$

ÜRÜN ÖZELLİKLERİ

- 1500-7000 lümen
- Batarya 7.3V 4000 mAh
- 6 Saatte Şarj
- Her Yöne Dönebilen LED
- USB-C Portu
- Tripot Ölçüleri: 800x100x95
- LED Ölçüleri: 210x100x95
- 1955 g



**PROFESYONEL
ÇÖZÜM ORTAĞINIZ**

RICO[®]
PROFESSIONAL

HAVALI GRUBU



www.rico.com.tr

3/8" - 1/2" CLASSIC AIR IMPACT WRENCH

3/8" - 1/2" MİNİ HAVALI **SOMUN SIKMA 80 KG**



Kare Ölçüsü 3/8" - 1/2"	Tork (Nm) 800
Ağırlık 1.34	Hortum Giriş Çapı 3/8
Hava Girişi 1/4	Cıvata Kapasitesi 5/8 (16)
Devir 8500	Hava Basıncı 90 (6.3)
Hava Tüketimi (l/min) 460	

KOD	ÜRÜN	1	10	FİYAT
022-RC4085	3/8"-1/2" Klasik Havalı Somun Sıkma Seti 80 Kg	1	10	230,00 \$

1/2" MINI AIR IMPACT WRENCH

1/2" MİNİ HAVALI **SOMUN SIKMA 1600 Nm**



Kare Ölçüsü 1/2"	Tork (Nm) 1100
Ağırlık 1.55	Max Tork (Nm) 1600
Hava Girişi 1/4	Hortum Giriş Çapı 3/8
Devir 9000	Cıvata Kapasitesi 5/8 (16)
Hava Tüketimi (l/min) 460	Hava Basıncı 90 (6.3)

KOD	ÜRÜN	1	10	FİYAT
022-RC4082	1/2" Mini Havalı Somun Sıkma 1600 Nm	1	10	75,00 \$

1/2" MINI AIR IMPACT WRENCH

1/2" MİNİ HAVALI **SOMUN SIKMA 50 KG**



Kare Ölçüsü 1/2"	Tork (Nm) 500
Ağırlık 1	Hortum Giriş Çapı 3/8
Hava Girişi 1/4	Cıvata Kapasitesi 5/8 (16)
Devir 8500	Hava Basıncı 90 (6.3)
Hava Tüketimi (l/min) 460	

KOD	ÜRÜN	1	10	FİYAT
022-RC4107	1/2" Mini Havalı Somun Sıkma 50 Kg	1	10	190,00 \$

1/2" AIR IMPACT WRENCH

1/2" HAVALI **SOMUN SIKMA 70 KG**



Kare Ölçüsü 1/2"	Tork (Nm) 700
Ağırlık 2.6	Hortum Giriş Çapı 3/8
Hava Girişi 1/4	Cıvata Kapasitesi 9/16 (14)
Devir 8000	Hava Basıncı 90 (6.3)
Hava Tüketimi (l/min) 460	

KOD	ÜRÜN	1	8	FİYAT
022-RC4108	1/2" Havalı Somun Sıkma 70 Kg	1	8	160,00 \$

1/2" AIR IMPACT WRENCH

1/2" HAVALI **SOMUN SIKMA SETİ 70 KG**







 Kare Ölçüsü 1/2"	 Tork (Nm) 720
 Ağırlık 2.68	 Hortum Giriş Çapı 3/8"
 Hava Girişi 1/4"	 Çivata Kapasitesi M18
 Devir 7000	 Hava Basıncı 90 (6.3)
 Hava Tüketimi 2 L/5	

KOD	ÜRÜN	1	6	FİYAT
022-RC4088	1/2" Havalı Somun Sıkma Seti 70 Kg	1	6	100,00 \$

3/4" AIR IMPACT WRENCH

3/4" HAVALI **SOMUN SIKMA**



 Kare Ölçüsü 3/4"	 Tork (Nm) 1300
 Ağırlık 8	 Hortum Giriş Çapı 1/2"
 Hava Girişi 3/8"	 Çivata Kapasitesi 1" (25)
 Devir 4500	 Hava Basıncı 90 (6.3)
 Hava Tüketimi (l/min) 198	

KOD	ÜRÜN	1	8	FİYAT
022-RC4086	3/4" Havalı Somun Sıkma	1	8	205,00 \$

1/2" AIR IMPACT WRENCH

1/2" HAVALI **SOMUN SIKMA 110 KG**



 Kare Ölçüsü 1/2"	 Tork (Nm) 1100
 Ağırlık 2.62	 Maksimum Tork (Nm) 1700
 Hava Girişi 1/4"	 Hortum Giriş Çapı 3/8"
 Devir 7500	 Çivata Kapasitesi 5/8 (16)
 Hava Tüketimi (l/min) 460	 Hava Basıncı 90 (6.3)







KOD	ÜRÜN	1	8	FİYAT
022-RC4110	1/2" Havalı Somun Sıkma 110 Kg	1	8	260,00 \$

3/4" AIR IMPACT WRENCH

3/4" HAVALI **SOMUN SIKMA 150 KG**



 Kare Ölçüsü 3/4"	 Tork (Nm) 1490
 Ağırlık 2.68	 Hortum Giriş Çapı 1/2"
 Hava Girişi 3/8"	 Çivata Kapasitesi 13/16 (20)
 Devir 7500	 Hava Basıncı 90 (6.3)
 Hava Tüketimi (l/min) 800	

KOD	ÜRÜN	1	8	FİYAT
022-RC4109	3/4" Havalı Somun Sıkma 150 Kg	1	8	340,00 \$

1" AIR IMPACT WRENCH
1" HAVALI **SOMUN SIKMA**

 Kare Ölçüsü 3/4" / 1"	 Tork (Nm) 2000
 Ağırlık 8	 Hortum Giriş Çapı 1/2"
 Hava Girişi 1/2"	 Çivata Kapasitesi M36
 Devir 4300	 Hava Basıncı 90 (6.3)
 Hava Tüketimi (l/min) 850	



1" AIR IMPACT WRENCH
1" PROF. **SOMUN SIKMA**

 Kare Ölçüsü 1"	 Tork (Nm) 3200
 Ağırlık 12	 Hortum Giriş Çapı 1/2"
 Hava Girişi 1/2"	 Çivata Kapasitesi M45
 Devir 4000	 Hava Basıncı 90 (6.3)
 Hava Tüketimi (l/min) 1100	



KOD	ÜRÜN	1	4	FİYAT
022-RC4087	1" Havalı Somun Sıkma	1	4	230,00 \$

KOD	ÜRÜN	1	2	FİYAT
022-RC4104	Prof. Somun Sıkma 1"	1	2	265,00 \$

1/2" AIR RATCHET HANDLE
1/2" HAVALI **CIRCIR KOLU**

 Kare Ölçüsü 1/2"	 Tork (Nm) 50
 Ağırlık 1	 Hortum Giriş Çapı 3/8
 Hava Girişi 1/4	 Çivata Kapasitesi 1/2 (13)
 Devir 160	 Hava Basıncı 90 (6.3)
 Hava Tüketimi (l/min) 113	



ANVİL
HAVALI **SOMUN SIKMA MİLİ**



KOD	ÜRÜN	1	20	FİYAT
022-RC4200	1/2" Havalı Cırcır Kolu Klasik	1	20	37,00 \$
022-RC4080	1/4 " Havalı Cırcır Kolu Klasik	1	20	32,40 \$

KOD	ÜRÜN	1	1	FİYAT
022-RC4108M	Havalı Somun Sıkma Mili 70kg	1	1	35,00 \$
022-RC4110M	Havalı Somun Sıkma Mili 110kg	1	1	35,00 \$

Made in
Türkiye

1/2" CHARGING IMPACT WRENCH

1/2" ŞARJLI **SOMUN SIKMA 500 Nm**



Bits Uç
Takılabilme
Özelliği

2
BATARYA

KOD	ÜRÜN	1	5	FİYAT
028-RE0006	1/2" Şarjlı Somun Sıkma	1	5	170,00 \$

1/2" CHARGING IMPACT WRENCH

1/2" ŞARJLI **SOMUN SIKMA 650 Nm**



2
BATARYA

KOD	ÜRÜN	1	5	FİYAT
028-RE0007	1/2" Şarjlı Somun Sıkma	1	5	210,00 \$

CORDLESS DRILL

ŞARJLI **MATKAP 20V**



2
BATARYA

KOD	ÜRÜN	1	5	FİYAT
028-RE0003	Şarjlı Matkap	1	5	120,00 \$



STOPER MALE BODY

STOPER **ERKEK GÖVDE**



Made in
Türkiye

KOD	ÜRÜN	📦	📦	FİYAT
022-RC3014	1/4"	25	500	3,35 \$
022-RC3015	3/8"	25	500	3,35 \$
022-RC3016	1/2"	25	500	3,35 \$

STOPER FEMALE BODY

STOPER **DİŞİ GÖVDE**



Made in
Türkiye

KOD	ÜRÜN	📦	📦	FİYAT
022-RC3017	1/4"	25	500	3,35 \$
022-RC3018	3/8"	25	500	3,35 \$
022-RC3019	1/2"	25	500	3,35 \$

STOPER BODY

STOPER **HORTUM GÖVDE**



Made in
Türkiye

KOD	ÜRÜN	📦	📦	FİYAT
022-RC3008	6mm	25	500	3,35 \$
022-RC3009	8mm	25	500	3,35 \$
022-RC3010	10mm	25	500	3,35 \$
022-RC3013	12mm	25	500	3,35 \$

STOPER HOSE TIP

STOPER **HORTUM UCU**



Made in
Türkiye

KOD	ÜRÜN	📦	📦	FİYAT
022-RC3004	6mm	25	500	0,85 \$
022-RC3005	8mm	25	500	0,85 \$
022-RC3006	10mm	25	500	0,85 \$
022-RC3007	12mm	25	500	0,85 \$

STOPER FEMALE TIP

STOPER **DİŞİ UÇ**



Made in
Türkiye

KOD	ÜRÜN	📦	📦	FİYAT
022-RC3023	1/4"	25	500	1,00 \$
022-RC3024	3/8"	25	500	1,35 \$
022-RC3025	1/2"	25	500	1,95 \$

STOPER MALE TIP

STOPER **ERKEK UÇ**



Made in
Türkiye

KOD	ÜRÜN	📦	📦	FİYAT
022-RC3020	1/4"	25	500	1,00 \$
022-RC3021	3/8"	25	500	1,35 \$
022-RC3022	1/2"	25	500	1,95 \$

T HOSE TIP

T **HORTUM UCU**



Made in
Türkiye

KOD	ÜRÜN	📦	📦	FİYAT
022-RC3000	8mm T.	25	500	2,50 \$
022-RC3001	10mm T.	25	500	3,10 \$

STOPER NETWORK

1/2" 3 LÜ **ÇATAL TAKIM**



Made in
Türkiye

KOD	ÜRÜN	📦	📦	FİYAT
022-RC3003	1/2"	5	100	16,00 \$

STOPER NETWORK

1/2" 2 Lİ **ÇATAL TAKIM**



Made in
Türkiye

KOD	ÜRÜN	📦	📦	FİYAT
022-RC3002	1/2"	5	100	11,00 \$

METAL AIR COMPRESSOR

METAL HAVA KOMPRESÖR **TEK SİLİNDİR**



METAL AIR COMPRESSOR

METAL HAVA KOMPRESÖR **ÇİFT SİLİNDİR**



KOD	ÜRÜN	1	4	FİYAT
FY-118	Tek Silindir	1	4	33,00 \$

KOD	ÜRÜN	1	4	FİYAT
FY-002C-1	Çift Silindir	1	4	55,00 \$

INDUSTRIAL HOTRUM AIR

HAVA HORTUMU
SİPİRALLİ



KOD	ÜRÜN	1	24	FİYAT
022-RC4113	8x12x7,5 m	1	24	14,00 \$
022-RC4114	8x12x15 m	1	24	21,00 \$
022-RC4111	5x8x7,5 m	1	36	7,50 \$
022-RC4112	5x8x15 m	1	36	12,75 \$

DİJİTAL TİRE İNFLATOR

DİJİTAL **HAVA SAATİ**



KOD	ÜRÜN	20	FİYAT
013-RC0014	Dijital Hava Saati	20	33,00 \$

TYRE INFLATING GUN

LASTİK ŞİŞİRME
HAVA SAATİ



KOD	ÜRÜN	40	FİYAT
013-RC1088	Hava Saati	40	11,15 \$

AIR DUST GUN WITH 20CM

HAVA TABANÇASI
20 CM NİKEL



KOD	ÜRÜN	10	50	FİYAT
013-RC0005	20cm	10	50	5,50 \$

AIR DUST GUN WITH 10CM

HAVA TABANÇASI
10 CM NİKEL



KOD	ÜRÜN	10	50	FİYAT
013-RC0010	10cm	10	50	5,10 \$

VALVE NEEDLE SCREWER

SİBOP **İĞNE TORNAVİDASI**



KOD	ÜRÜN	20	FİYAT
013-KK1134	Sibop İğne Tornavidası	20	1,75 \$

**PROFESYONEL
ÇÖZÜM ORTAĞINIZ**

RIGID[®]
PROFESSIONAL

MATKAP UÇLARI



www.rigo.com.fr

TITANIUM COATED DRILL

TİTANYUM KAPLI MATKAP UCU

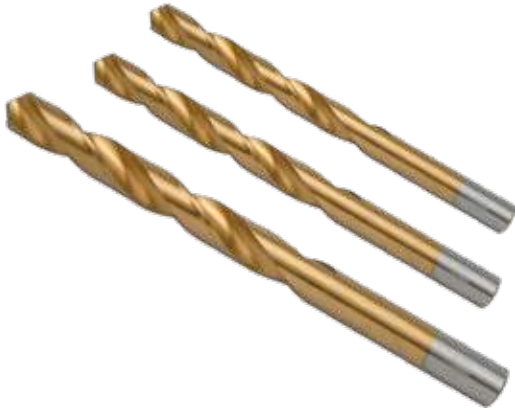

TITANIUM COATED DRILL W/BLISTER

BİLİSTERLİ TİTANYUM KAPLI MATKAP UCU



KOD	ÜRÜN	📦	📦	FİYAT
008-RT4408	Titan. Kaplı Matkap Ucu 0,8 mm	1	100	0,23 \$
008-RT4410	Titan. Kaplı Matkap Ucu 1 mm	1	100	0,25 \$
008-RT4415	Titan. Kaplı Matkap Ucu 1,5 mm	1	100	0,26 \$
008-RT4420	Titan. Kaplı Matkap Ucu 2 mm	1	100	0,29 \$
008-RT4422	Titan. Kaplı Matkap Ucu 2,2 mm	1	100	0,31 \$
008-RT4425	Titan. Kaplı Matkap Ucu 2,5 mm	1	100	0,33 \$
008-RT4430	Titan. Kaplı Matkap Ucu 3 mm	1	100	0,46 \$
008-RT4432	Titan. Kaplı Matkap Ucu 3,2 mm	1	100	0,49 \$
008-RT4435	Titan. Kaplı Matkap Ucu 3,5 mm	1	100	0,52 \$
008-RT4438	Titan. Kaplı Matkap Ucu 3,8 mm	1	100	0,60 \$
008-RT4440	Titan. Kaplı Matkap Ucu 4 mm	1	100	0,76 \$
008-RT4442	Titan. Kaplı Matkap Ucu 4,2 mm	1	100	0,92 \$
008-RT4444	Titan. Kaplı Matkap Ucu 4,4 mm	1	100	0,98 \$
008-RT4445	Titan. Kaplı Matkap Ucu 4,5 mm	1	100	1,03 \$
008-RT4448	Titan. Kaplı Matkap Ucu 4,8 mm	1	100	1,10 \$
008-RT4450	Titan. Kaplı Matkap Ucu 5 mm	1	100	1,14 \$
008-RT4452	Titan. Kaplı Matkap Ucu 5,2 mm	1	100	1,25 \$
008-RT4455	Titan. Kaplı Matkap Ucu 5,5 mm	1	100	1,52 \$
008-RT4458	Titan. Kaplı Matkap Ucu 5,8 mm	1	100	1,58 \$
008-RT4460	Titan. Kaplı Matkap Ucu 6 mm	1	50	1,63 \$
008-RT4465	Titan. Kaplı Matkap Ucu 6,5 mm	1	50	2,07 \$
008-RT4467	Titan. Kaplı Matkap Ucu 6,7 mm	1	50	2,18 \$
008-RT4468	Titan. Kaplı Matkap Ucu 6,8 mm	1	50	2,29 \$
008-RT4470	Titan. Kaplı Matkap Ucu 7 mm	1	50	2,45 \$
008-RT4475	Titan. Kaplı Matkap Ucu 7,5 mm	1	50	2,72 \$
008-RT4480	Titan. Kaplı Matkap Ucu 8 mm	1	50	3,27 \$
008-RT4485	Titan. Kaplı Matkap Ucu 8,5 mm	1	50	3,60 \$
008-RT4490	Titan. Kaplı Matkap Ucu 9 mm	1	50	4,14 \$
008-RT4595	Titan. Kaplı Matkap Ucu 9,5 mm	1	50	4,90 \$
008-RT4491	Titan. Kaplı Matkap Ucu 10 mm	1	50	5,45 \$
008-RT4499	Titan. Kaplı Matkap Ucu 10,2 mm	1	50	6,25 \$
008-RT4497	Titan. Kaplı Matkap Ucu 10,5 mm	1	50	6,54 \$
008-RT4500	Titan. Kaplı Matkap Ucu 11 mm	1	50	6,80 \$
008-RT4501	Titan. Kaplı Matkap Ucu 11,5 mm	1	20	7,10 \$
008-RT4492	Titan. Kaplı Matkap Ucu 12 mm	1	20	7,35 \$
008-RT4502	Titan. Kaplı Matkap Ucu 12,5 mm	1	20	8,15 \$
008-RT4493	Titan. Kaplı Matkap Ucu 13 mm	1	20	8,70 \$
008-RT4494	Titan. Kaplı Matkap Ucu 14 mm	1	10	12,00 \$
008-RT4495	Titan. Kaplı Matkap Ucu 15 mm	1	10	14,20 \$
008-RT4496	Titan. Kaplı Matkap Ucu 16 mm	1	10	16,35 \$

KOD	ÜRÜN	📦	📦	FİYAT
008-RT4308	Bilisterli Titan.Kaplı Matkap Ucu 0,8 mm	1	50	0,50 \$
008-RT4310	Bilisterli Titan.Kaplı Matkap Ucu 1 mm	1	50	0,55 \$
008-RT4315	Bilisterli Titan.Kaplı Matkap Ucu 1,5 mm	1	50	0,60 \$
008-RT4320	Bilisterli Titan.Kaplı Matkap Ucu 2 mm	1	50	0,62 \$
008-RT4325	Bilisterli Titan.Kaplı Matkap Ucu 2,5 mm	1	50	0,65 \$
008-RT4330	Bilisterli Titan.Kaplı Matkap Ucu 3 mm	1	50	0,80 \$
008-RT4332	Bilisterli Titan.Kaplı Matkap Ucu 3,2 mm	1	50	0,82 \$
008-RT4335	Bilisterli Titan.Kaplı Matkap Ucu 3,5 mm	1	50	0,84 \$
008-RT4340	Bilisterli Titan.Kaplı Matkap Ucu 4 mm	1	50	1,10 \$
008-RT4342	Bilisterli Titan.Kaplı Matkap Ucu 4,2 mm	1	50	1,25 \$
008-RT4345	Bilisterli Titan.Kaplı Matkap Ucu 4,5 mm	1	50	1,28 \$
008-RT4350	Bilisterli Titan.Kaplı Matkap Ucu 5 mm	1	50	1,50 \$
008-RT4355	Bilisterli Titan.Kaplı Matkap Ucu 5,5 mm	1	50	1,75 \$
008-RT4360	Bilisterli Titan.Kaplı Matkap Ucu 6 mm	1	50	2,00 \$
008-RT4365	Bilisterli Titan.Kaplı Matkap Ucu 6,5 mm	1	50	2,50 \$
008-RT4370	Bilisterli Titan.Kaplı Matkap Ucu 7 mm	1	50	2,75 \$
008-RT4375	Bilisterli Titan.Kaplı Matkap Ucu 7,5 mm	1	50	3,00 \$
008-RT4380	Bilisterli Titan.Kaplı Matkap Ucu 8 mm	1	50	3,55 \$
008-RT4385	Bilisterli Titan.Kaplı Matkap Ucu 8,5 mm	1	50	3,80 \$
008-RT4390	Bilisterli Titan.Kaplı Matkap Ucu 9 mm	1	50	4,55 \$
008-RT4395	Bilisterli Titan.Kaplı Matkap Ucu 9,5 mm	1	50	5,15 \$
008-RT4396	Bilisterli Titan.Kaplı Matkap Ucu 10 mm	1	20	5,70 \$
008-RT4397	Bilisterli Titan.Kaplı Matkap Ucu 10,5mm	1	20	6,80 \$
008-RT4398	Bilisterli Titan.Kaplı Matkap Ucu 11 mm	1	20	7,10 \$
008-RT4399	Bilisterli Titan.Kaplı Matkap Ucu 11,5 mm	1	20	7,40 \$
008-RT4400	Bilisterli Titan.Kaplı Matkap Ucu 12 mm	1	20	7,65 \$
008-RT4401	Bilisterli Titan.Kaplı Matkap Ucu 12,5mm	1	20	8,40 \$
008-RT4402	Bilisterli Titan.Kaplı Matkap Ucu 13 mm	1	20	9,10 \$
008-RT4403	Bilisterli Titan.Kaplı Matkap Ucu 14 mm	1	10	12,50 \$
008-RT4404	Bilisterli Titan.Kaplı Matkap Ucu 15 mm	1	10	14,60 \$
008-RT4405	Bilisterli Titan.Kaplı Matkap Ucu 16 mm	1	10	16,80 \$

STEP DRILL 4-20MM

KADEMELİ MATKAP UCU
4-20MM



STEP DRILL 4-32MM

KADEMELİ MATKAP UCU
4-32MM



KOD	ÜRÜN	📦	📦	FİYAT
008-RC2000	Kademeli Matkap Ucu 4-20mm	1	20	5,50 \$

KOD	ÜRÜN	📦	📦	FİYAT
008-RC2001	Kademeli Matkap Ucu 4-32mm	1	20	11,00 \$

16PCS COMBINATON DRILL SET

16 PARÇA
MATKAP UCU SETİ



KOD	ÜRÜN	📦	📦	FİYAT
009-RC1106	16 PC	1	25	13,00 \$

İçindekiler: 2, 3, 4, 5, 6, 8 mm | 4, 5, 6, 8, 10 mm | 4, 5, 6, 8, 10 mm

8PCS WOOD WORKING DRILL SET

8 PARÇA AĞAÇ
MATKAP UCU SETİ



KOD	ÜRÜN	📦	📦	FİYAT
009-RC1103	8 PC	1	50	4,00 \$

İçindekiler: 3, 4, 5, 6, 7, 8, 9, 10 mm

8PCS MASONRY DRILL SET

8 PARÇA BETON
MATKAP UCU SETİ



KOD	ÜRÜN	📦	📦	FİYAT
009-RC1101	8 PC	1	50	7,00 \$

İçindekiler: 3, 4, 5, 6, 7, 8, 9, 10 mm

9PCS COMBINATION DRILL SET

9 PARÇA
MATKAP UCU SETİ



KOD	ÜRÜN	📦	📦	FİYAT
009-RC1105	9 PC	1	50	7,00 \$

İçindekiler: 5, 6, 8 mm | 5, 6, 8 mm | 5, 6, 8 mm

6PCS FLAT WOODEN BITS SET

6 PARÇA YAPRAK
MATKAP UCU SETİ



KOD	ÜRÜN	📦	📦	FİYAT
013-RC1300	6 PC	25	100	5,00 \$

İçindekiler: 10, 12, 16, 18, 20, 25 mm

6PCS HEX WOODEN BITS SET

6 PARÇA YAPRAK HEX
MATKAP UCU SETİ



KOD	ÜRÜN	📦	📦	FİYAT
013-RC1299	6 PC	25	100	6,00 \$

İçindekiler: 12, 16, 18, 20, 22, 24 mm

**PROFESYONEL
ÇÖZÜM ORTAĞINIZ**

RICO[®]
PROFESSIONAL

KESKİ, EĞE, ÇEKİÇ



www.rico.com.tr

WOOD HAMMER

AĞAÇ SAPLI ÇEKİÇ

Made in
Türkiye

KOD	ÜRÜN			FİYAT
016-RC3831	Ağaç Saplı Çekiç 100 gr	1	12	3,30 \$
016-RC3832	Ağaç Saplı Çekiç 200 gr	1	12	3,65 \$
016-RC3833	Ağaç Saplı Çekiç 300 gr	1	6	4,75 \$
016-RC3835	Ağaç Saplı Çekiç 500 gr	1	6	5,65 \$
016-RC3836	Ağaç Saplı Çekiç 1000gr	1	6	8,30 \$
016-RC3837	Ağaç Saplı Çekiç 1500 gr	1	4	10,55 \$
016-RC3838	Ağaç Saplı Çekiç 2000 gr	1	4	13,00 \$

GLASS HAMMER W/WOODEN HANDLE

AĞAÇ SAPLI CAMCI ÇEKİÇ

Made in
Türkiye

KOD	ÜRÜN			FİYAT
016-RC3846	Ağaç Saplı Camcı Çekiç	10	100	4,32 \$

AXE

SAPLI KESER

Made in
Türkiye

KOD	ÜRÜN			FİYAT
016-RC4601	Saplı Keser	6	60	9,00 \$

FLAT CHISEL

DÜZ KESKİ

Made in
Türkiye

KOD	ÜRÜN			FİYAT
008-RC8251	Düz Keski 150mm	6	48	3,75 \$
008-RC8252	Düz Keski 175mm	6	48	4,50 \$
008-RC8253	Düz Keski 200mm	6	48	5,40 \$
008-RC8250	Düz Keski 250mm	6	48	6,40 \$

PIN PUNCH

PİM SÖKME İZOLELİ



Made in
Türkiye

PIN REMOVAL FLAT NON INSULATED

PİM SÖKME DÜZ İZOLESİZ



Made in
Türkiye

KOD	ÜRÜN			FİYAT
008-RC7001	Pim Sökme İzoleli 3 mm	12	48	2,90 \$
008-RC7004	Pim Sökme İzoleli 6 mm	6	48	2,90 \$
008-RC7005	Pim Sökme İzoleli 8 mm	6	48	5,30 \$

KOD	ÜRÜN			FİYAT
008-RC6090	Pim Sökme İzolesiz 2 mm	12	48	2,70 \$
008-RC6091	Pim Sökme İzolesiz 3 mm	12	48	2,70 \$
008-RC6092	Pim Sökme İzolesiz 4 mm	6	48	2,70 \$
008-RC6093	Pim Sökme İzolesiz 5 mm	6	48	2,70 \$
008-RC6094	Pim Sökme İzolesiz 6 mm	6	48	3,25 \$
008-RC6095	Pim Sökme İzolesiz 8 mm	6	48	3,25 \$

6 PIECE PIN REMOVAL FLAT SET

6 PARÇA PİM SÖKME SETİ DÜZ

Made in
Türkiye

KOD	ÜRÜN			FİYAT
008-RC7011	6 Parça Pim Sökme Seti Düz	1	50	17,30 \$



COARSE FILE TRIANGLE

ÜÇGEN TAPER EĞE



KOD	ÜRÜN			FİYAT
012-RC1500	Üçgen Taper Eğe 5 mm	1 Dz.	30	21,85 \$
012-RC1600	Üçgen Taper Eğe 6 mm	1 Dz.	24	25,30 \$
012-RC1700	Üçgen Taper Eğe 7 mm	1 Dz.	15	28,75 \$
012-RC1800	Üçgen Taper Eğe 8 mm	1 Dz.	15	32,20 \$

COARSE FILE TRIANGLE W/BLISTER

TAPER EĞE BLİSTERLİ



KOD	ÜRÜN			FİYAT
012-BB1500	Taper Eğe 5mm Blisterli	1 Ad.	24	2,30 \$
012-BB1600	Taper Eğe 6mm Blisterli	1Ad.	24	2,58 \$
012-BB1700	Taper Eğe 7mm Blisterli	1Ad.	24	2,76 \$
012-BB1800	Taper Eğe 8mm Blisterli	1 Ad.	24	3,10 \$

SLIM FILE TRIANGLE

ÜÇGEN SLİM EĞE



KOD	ÜRÜN			FİYAT
012-RC0040	Üçgen Slim Eğe 4 mm Extra İnce	1 Dz.	130	11,50 \$
012-RC0400	Üçgen Slim Eğe 4 mm	1 Dz.	120	11,50 \$
012-RC0500	Üçgen Slim Eğe 5 mm	1 Dz.	80	18,40 \$
012-RC0600	Üçgen Slim Eğe 6 mm	1 Dz.	60	20,70 \$
012-RC0700	Üçgen Slim Eğe 7 mm	1 Dz.	40	23,00 \$

SLIM FILE TRIANGLE W/BLISTER

ÜÇGEN SLİM EĞE BLİSTERLİ



KOD	ÜRÜN			FİYAT
012-BB0400	Üçgen Slim Eğe 4mm Blisterli	1 Ad.	24	1,32 \$
012-BB0500	Üçgen Slim Eğe 5mm Blisterli	1Ad.	24	1,90 \$
012-BB0600	Üçgen Slim Eğe 6mm Blisterli	1 Ad.	24	2,30 \$
012-BB0700	Üçgen Slim Eğe 7mm Blisterli	1Ad.	24	2,87 \$

ROUND FILE

YUVARLAK EĞE



KOD	ÜRÜN			FİYAT
012-RC5080	Yuvarlak Eğe 8 mm	1 Dz.	15	25,30 \$
012-RC5100	Yuvarlak Eğe 10 mm	1Dz.	8	31,00 \$
012-RC5120	Yuvarlak Eğe 12 mm	1 Dz.	5	38,00 \$

ROUND FILE W/BLISTER

YUVARLAK EĞE BLİSTERLİ



KOD	ÜRÜN			FİYAT
012-BB5080	Yuvarlak Eğe Blisterli 8mm	1 Ad.	24	2,53 \$
012-BB5100	Yuvarlak Eğe Blisterli 10mm	1 Ad.	24	3,00 \$

HALF ROUND FILE

YARIM YUVARLAK EĞE



KOD	ÜRÜN	📦	📦	FİYAT
012-RC4060	Yarım Yuvarlak Eğe 6 mm	1 Dz.	30	30,00 \$
012-RC4080	Yarım Yuvarlak Eğe 8 mm	1 Dz.	15	36,80 \$
012-RC4100	Yarım Yuvarlak Eğe 10 mm	1 Dz.	8	48,30 \$
012-RC4120	Yarım Yuvarlak Eğe 12 mm	1 Dz.	5	65,00 \$

FLAT SLIM

YASSI EĞE İNCE DİŞ

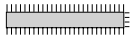

KOD	ÜRÜN	📦	📦	FİYAT
012-RC2040	Yassı Eğe 4 mm İnce Diş	1 Dz.	120	25,30 \$
012-RC2060	Yassı Eğe 6 mm İnce Diş	1 Dz.	30	27,60 \$
012-RC2080	Yassı Eğe 8 mm İnce Diş	1 Dz.	15	32,20 \$
012-RC2100	Yassı Eğe 10 mm İnce Diş	1 Dz.	8	43,70 \$
012-RC2120	Yassı Eğe 12 mm İnce Diş	1 Dz.	5	70,00 \$

WOOD RASP

AĞAÇ TÖRPÜ

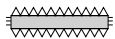

KOD	ÜRÜN	📦	📦	FİYAT
012-RC6110	Ağaç Törpü 10 mm	1 Dz.	10	32,20 \$
012-RC6112	Ağaç Törpü 12 mm	1 Dz.	5	38,00 \$

HALF ROUND FILE W/BLISTER

YARIM YUVARLAK EĞE BLİSTERLİ

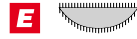

KOD	ÜRÜN	📦	📦	FİYAT
012-BB4060	Yarım Yuvarlak Eğe 6mm Blisterli	1 Ad.	24	2,93 \$
012-BB4080	Yarım Yuvarlak Eğe 8mm Blisterli	1 Ad.	24	3,45 \$
012-BB4100	Yarım Yuvarlak Eğe 10mm Blisterli	1 Ad.	24	4,42 \$

FLAT SLIM THIN W/BLISTER

YASSI EĞE BLİSTERLİ İNCE DİŞ

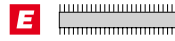

KOD	ÜRÜN	📦	📦	FİYAT
012-BB2040	Yassı Eğe İnce Diş 4mm Blisterli	1 Ad.	24	2,53 \$
012-BB2060	Yassı Eğe İnce Diş 6mm Blisterli	1 Ad.	24	2,76 \$
012-BB2080	Yassı Eğe İnce Diş 8mm Blisterli	1 Ad.	24	3,16 \$
012-BB2100	Yassı Eğe İnce Diş 10mm Blisterli	1 Ad.	24	4,14 \$

RASP 10MM W/BLISTER

TÖRPÜ 10MM BLİSTERLİ

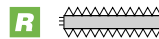

KOD	ÜRÜN	📦	📦	FİYAT
012-BB6110	Törpü 10mm Blisterli	1Ad.	24	3,10 \$

FLAT COARSE FILE

YASSI EĞE KALIN DİŞ

KOD	ÜRÜN	📦	📦	FİYAT
012-RC3060	Yassı Eğe 6 mm Kalın Diş	1 Dz.	30	27,60 \$
012-RC3080	Yassı Eğe 8 mm Kalın Diş	1 Dz.	15	32,20 \$
012-RC3100	Yassı Eğe 10 mm Kalın Diş	1 Dz.	8	43,70 \$
012-RC3120	Yassı Eğe 12 mm Kalın Diş	1 Dz.	5	70,00 \$

FLAT COARSE FILE W/BLISTER

YASSI EĞE BLİSTERLİ KALIN DİŞ

KOD	ÜRÜN	📦	📦	FİYAT
012-BB3060	Yassı Eğe Kalın Diş 6mm Blisterli	1 Ad.	24	2,76 \$
012-BB3080	Yassı Eğe Kalın Diş 8mm Blisterli	1 Ad.	24	3,16 \$
012-BB3100	Yassı Eğe Kalın Diş 10mm Blisterli	1 Ad.	24	4,14 \$

SQUARE FILE

KARE EĞE

KOD	ÜRÜN	📦	📦	FİYAT
012-RC7778	Kare Eğe 8"	1 Dz.	15	27,60 \$
012-RC7780	Kare Eğe 10"	1 Dz.	8	33,35 \$
012-RC7782	Kare Eğe 12"	1 Dz.	5	39,10 \$

SQUARE FILE W/BLISTER

KARE EĞE BLİSTERLİ

KOD	ÜRÜN	📦	📦	FİYAT
012-BB7778	Kare 8mm Blisterli	1 Ad.	24	2,65 \$
012-BB7780	Kare 10mm Blisterli	1 Ad.	24	3,16 \$

5 PIECE FILE SET 8"

5 PARÇA EĞE SETİ 8"

KOD	ÜRÜN	📦	📦	FİYAT
012-RC2160	5 Parça Eğe Seti 8"	10	20	15,00 \$

5 PIECE DIAMOND FILE SET

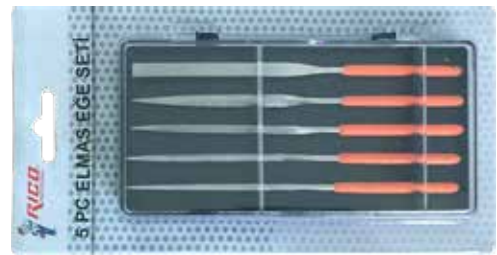
5 PARÇA ELMAS EĞE SETİ

KOD	ÜRÜN	📦	📦	FİYAT
012-RC2140	5 Parça Elmas Eğe Seti	50	200	7,00 \$

FILE HANDLE

EĞE SAPI



RICO EĞELER

- E** Standart eğeler – Şekillendirilmiş Parçaların yüzey işlemlerinde kullanım için.
- S** Testere eğeleri – Ağaç testereleri ve benzer ince kenarları keskinleştirmek için.
- R** Törpü – Ağaç, deri ve benzer yumuşak malzemelerde kullanım için.
- Çift Kesim: Çelik ve diğer malzemelerde kullanım.
- Tek Kesim: Testere keskinleştirmek, ince yüzey elde etmede kullanım.
- Raspa Kesim: Ahşap ve yumuşak malzemelerde kullanım.



KOD	ÜRÜN	1	100	FİYAT
024-BB8011	Eğе Sapı	1	100	0,70 \$

MINI FIXED VICE

SABİT MİNİ MASA MENGENE



KOD	ÜRÜN	1	40	30	20	20	FİYAT
013-RC1480	Mini Masa Mengene Sabit 40 mm	1	40	30	20	20	8,28 \$
013-RC1481	Mini Masa Mengene Sabit 50 mm	1	30	20	20	20	9,66 \$
013-RC1482	Mini Masa Mengene Sabit 60 mm	1	20	20	20	20	11,00 \$
013-RC1483	Mini Masa Mengene Sabit 70 mm	1	20	20	20	20	14,50 \$

200W SOLDERING IRON

200W TABANCA HAVYA



100W SOLDERING IRON

100W TABANCA HAVYA



KOD	ÜRÜN	1	5	FİYAT
014-KK1935	200W TABANCA HAVYA	1	5	35,00 \$

KOD	ÜRÜN	1	10	FİYAT
014-KK1934	100W TABANCA HAVYA	1	10	22,00 \$

CAR BODY SHOP HAMMER
KAPORTACI ÇEKİCİMade in
Türkiye

KOD	ÜRÜN	6	24	FİYAT
016-RC3847	Oto Doğrultma Çekici KÇ-01	6	24	15,00 \$

CAR BODY SHOP HAMMER
KAPORTACI ÇEKİCİMade in
Türkiye

KOD	ÜRÜN	6	24	FİYAT
016-RC3848	Oto Doğrultma Çekici KÇ-02	6	24	15,00 \$

CAR BODY SHOP HAMMER
KAPORTACI ÇEKİCİMade in
Türkiye

KOD	ÜRÜN	6	24	FİYAT
016-RC3849	Oto Doğrultma Çekici KÇ-03	6	24	15,00 \$

CAR BODY SHOP HAMMER
KAPORTACI ÇEKİCİMade in
Türkiye

KOD	ÜRÜN	6	24	FİYAT
016-RC3850	Oto Doğrultma Çekici KÇ-04	6	24	15,00 \$

CAR BODY SHOP HAMMER
KAPORTACI ÇEKİCİMade in
Türkiye

KOD	ÜRÜN	6	24	FİYAT
016-RC3851	Oto Doğrultma Çekici KÇ-05	6	24	15,00 \$

CAR BODY SHOP HAMMER
KAPORTACI ÇEKİCİMade in
Türkiye

KOD	ÜRÜN	6	24	FİYAT
016-RC3852	Oto Doğrultma Çekici KÇ-06	6	24	15,00 \$

CAR BODY SHOP HAMMER
KAPORTACI ÇEKİCİ



Made in
Türkiye

KOD	ÜRÜN	6	24	FİYAT
016-RC3853	Oto Doğrultma Çekici KÇ-07	6	24	15,00 \$

CAR BODY SHOP HAMMER
KAPORTACI ÇEKİCİ



Made in
Türkiye

KOD	ÜRÜN	6	24	FİYAT
016-RC3854	Oto Doğrultma Çekici KÇ-08	6	24	15,00 \$

CAR BODY SHOP HAMMER
KAPORTACI ÇEKİCİ



Made in
Türkiye

KOD	ÜRÜN	6	24	FİYAT
016-RC3855	Oto Doğrultma Çekici KÇ-09	6	24	15,00 \$

CAR BODY SHOP HAMMER
KAPORTACI ÇEKİCİ



Made in
Türkiye

KOD	ÜRÜN	6	24	FİYAT
016-RC3856	Oto Doğrultma Çekici KÇ-10	6	24	15,00 \$

CAR BODY SHOP HAMMER
KAPORTACI ÇEKİCİ



Made in
Türkiye

KOD	ÜRÜN	6	24	FİYAT
016-RC3861	Oto Doğrultma Çekici KÇ-11	6	24	15,00 \$

CAR BODY SHOP HAMMER
KAPORTACI ÇEKİCİ



Made in
Türkiye

KOD	ÜRÜN	6	24	FİYAT
016-RC3862	Oto Doğrultma Çekici KÇ-12	6	24	15,00 \$

CAR BODY SHOP HAMMER
KAPORTACI ÇEKİCİMade in
Türkiye

KOD	ÜRÜN	📦	📦	FİYAT
016-RC3877	Oto Doğrultma Çekici KÇ-13	6	24	15,00 \$

PRY AND BUMPING SPOON
TRANÇA ÇEKİCİMade in
Türkiye

KOD	ÜRÜN	📦	📦	FİYAT
016-RC3857	Trança TR-01	1	1	22,00 \$

HEAVY DUTY BODY WORK SPOON
TRANÇA ÇEKİCİMade in
Türkiye

KOD	ÜRÜN	📦	📦	FİYAT
016-RC3858	Trança TR-02	1	1	24,00 \$

BODY WORK LEVER
TRANÇA ÇEKİCİMade in
Türkiye

KOD	ÜRÜN	📦	📦	FİYAT
016-RC3859	Trança TR-03	1	1	20,00 \$

BODY WORK LEVER
TRANÇA ÇEKİCİMade in
Türkiye

KOD	ÜRÜN	📦	📦	FİYAT
016-RC3860	Trança TR-04	1	1	22,00 \$

LONG DOUBLE ENDED BODY WORK LEVER
TRANÇA ÇEKİCİMade in
Türkiye

KOD	ÜRÜN	📦	📦	FİYAT
016-RC3863	Trança Çekici TR-05	1	1	40,00 \$

POINTED BACK

DAYAMA SİVRİ TİP D-11



Made in
Türkiye

KOD	ÜRÜN	📦	📦	FİYAT
016-RC3875	Dayama Sivri Tip D-11	2	20	18,40 \$

TONGUE REST

DAYAMA UZUN DİL D-10



Made in
Türkiye

KOD	ÜRÜN	📦	📦	FİYAT
016-RC3874	Dayama Uzun Dil D-10	2	20	18,40 \$

PAINTLESS DENT REPAIR HAMMER TR-06

BOYASIZ GÖÇÜK DÜZELTME ÇEKİCİ TR-06



Made in
Türkiye

KOD	ÜRÜN	📦	📦	FİYAT
016-RC3876	Boyasız Göçük Düzeltme Çekici Tr-06	2	20	17,60 \$

11 PC BODYWORK TOOL SET

11 PC KAPORTA DAYAMA SETİ



KOD	ÜRÜN	📦	📦	FİYAT
016-RC3864	11 Pç Kaporta Dayama Seti	1	1	195,00 \$

PLANISHING HAND ANVILS

KAPORTA DAYAMA



Made in
Türkiye

KOD	ÜRÜN	📦	📦	FİYAT
016-RC3865	Kama Dayama D-1	1	1	16,50 \$
016-RC3867	Topuz Dayama D-3	1	1	16,50 \$
016-RC3870	Tabaka Dayama D-6	1	1	16,50 \$
016-RC3868	Dil Dayama D-4	1	1	17,70 \$
016-RC3866	Kelebek Dayama D-2	1	1	17,70 \$
016-RC3869	Ökçe Dayama D-5	1	1	17,70 \$
016-RC3871	Virgül Dayama D-7	1	1	18,30 \$
016-RC3872	Ray Dayama D-8	1	1	18,30 \$
016-RC3873	Bombeli Kama Dayama D-9	1	1	18,30 \$

**PROFESYONEL
ÇÖZÜM ORTAĞINIZ**

RIEHO[®]
PROFESSIONAL

BAHÇE GRUBU



www.riego.com.tr

PURNING SHEAR R22

BAĞ MAKASI R-22

PURNING SHEAR R23

BAĞ MAKASI R-23

KOD	ÜRÜN	📦	📦	FİYAT
025-RC4481	R-22 Bağ Makası 9"	6	60	21,85 \$

KOD	ÜRÜN	📦	📦	FİYAT
025-RC4480	R-23 Bağ Makası 8"	6	60	20,70 \$

PURNING SHEAR R-16

TEFLONLU BAĞ MAKASI R-16

PURNING SHEAR R29

BAĞ MAKASI R-29Made in
Türkiye

KOD	ÜRÜN	📦	📦	FİYAT
025-RC4599	R-16 Teflon Bağ Makası	6	60	12,19 \$

KOD	ÜRÜN	📦	📦	FİYAT
025-RC4604	Bağ Makası R-29	10	60	9,77 \$

PURNING SHEAR R24

BAĞ MAKASI R-24

PURNING SHEAR R-7

BAĞ MAKASI R-7

KOD	ÜRÜN	📦	📦	FİYAT
025-RC4602	R-24 Bağ Makası 8"	6	60	16,00 \$

KOD	ÜRÜN	📦	📦	FİYAT
025-RC4478	R-7 Bağ Makası	6	60	32,00 \$

PURNING SHEAR R-8

BAĞ MAKASI R-8

KOD	ÜRÜN	6	60	FİYAT
025-RC4578	R-8 Bağ Makası	6	60	20,00 \$

PURNING SHEAR R-18

BAĞ MAKASI R-18

KOD	ÜRÜN	6	60	FİYAT
025-RC4594	R-18 Bağ Makası	6	60	26,00 \$

PURNING SHEAR R-11

BAĞ MAKASI R-11

KOD	ÜRÜN	6	60	FİYAT
025-RC4587	R-11 Bağ Makası	6	60	29,00 \$

PURNING SHEAR R-1

BAĞ MAKASI R-1

KOD	ÜRÜN	6	60	FİYAT
025-RC4579	R-1 Bağ Makası	6	60	19,00 \$

BRANCH SHEAR R-12

DAL MAKASI R-12

KOD	ÜRÜN	6	60	FİYAT
025-RC4591	R-12 Bağ Makası	6	60	18,00 \$

BRANCH SHEAR R-13

DAL MAKASI R-13

KOD	ÜRÜN	6	60	FİYAT
025-RC4590	R-13 Bağ Makası	6	60	33,50 \$

GRASS SHEARS R-24

ÇİMEN MAKASI R-24

KOD	ÜRÜN	📦	📦	FİYAT
025-RC4482	60-75 cm	6	60	18,00 \$

GRASS SHEARS R-25

ÇİMEN MAKASI R-25

KOD	ÜRÜN	📦	📦	FİYAT
025-RC4483	52.5 cm	6	60	11,70 \$

BRANCH SHEAR R-1

KALIN DAL MAKASI R-1

KOD	ÜRÜN	📦	📦	FİYAT
025-RC4486	73-97 cm	6	60	30,00 \$

EXTENDABLE BRANCH SHEAR R-2

UZAYABİLİR KALIN DAL MAKASI R-2

KOD	ÜRÜN	📦	📦	FİYAT
025-RC4487	73-97 cm	6	60	30,00 \$

BRANCH SHEAR R-3

DAL MAKASI R-3

KOD	ÜRÜN	📦	📦	FİYAT
025-RC4488	62-93 cm	6	60	16,00 \$



CHARGER PURNING SHEAR R40

ŞARJLI BAĞ MAKASI R-040

KOD	ÜRÜN	📦	📦	FİYAT
025-RC4608	Şarjlı Bağ Makası R-040	10	60	310,00 \$

ÜRÜN ÖZELLİKLERİ

16.8V - 0-40 Kesim Çapı - 2 adet 2.0 Ah Batarya - Yedek Bıçak - Montaj Aparatları - Bileme Taşı - Led Göstergeli Sayaç -



CHARGER PURNING SHEAR R035

ŞARJLI BAĞ MAKASI R-035

KOD	ÜRÜN	📦	📦	FİYAT
025-RC4607	Şarjlı Bağ Makası R-035	10	60	260,00 \$

ÜRÜN ÖZELLİKLERİ

16.8V - 0-35 Kesim Çapı - 2 adet 4.0 Ah Batarya - Yedek Bıçak - Montaj Aparatları - Bileme Taşı - Led Göstergeli Sayaç



CHARGER PURNING SHEAR R032

ŞARJLI BAĞ MAKASI R-032

KOD	ÜRÜN	📦	📦	FİYAT
025-RC4606	Şarjlı Bağ Makası R-032	10	60	214,00 \$

ÜRÜN ÖZELLİKLERİ

16.8V - 0-32 Kesim Çapı - 3 adet 2.6 Ah Batarya - Yedek Bıçak - Montaj Aparatları - Bileme Taşı - Led Göstergeli Sayaç



CHAINSAW

AKÜLÜ ZİNCİRLİ TESTERE

KOD	ÜRÜN	📦	📦	FİYAT
028-RE0002	Akülü Zincirli Testere	10	60	165,00 \$

ÜRÜN ÖZELLİKLERİ

21 V - 4 Ah - Lithium-ion Batarya

PROFESSIONAL CHAINSAW

PROFESYONEL AKÜLÜ ZİNCİRLİ TESTERE

KOD	ÜRÜN	📦	📦	FİYAT
028-RE0001	Profesyonel Akülü Zincirli Testere	10	60	310,00 \$

ÜRÜN ÖZELLİKLERİ

21 V - 4 Ah - Lithium-ion Batarya

TELESCOPIC EXTENSION

TELESKOPIK UZATMA

KOD	ÜRÜN	📦	📦	FİYAT
025-RC4609	Akülü Makas ve Testere için Teleskopik Uzatma - 3m	10	60	72,00 \$

ÜRÜN ÖZELLİKLERİ

- 4 Kademeli katlanabilir açılı
- 1,25m'den 3m'ye kadar uzayabilen metal aksam.



SAW TO TRIM W/CASE

BUDAMA TESTERE KILIFLI

KOD	ÜRÜN	📦	📦	FİYAT
018-RC2250	Budama Testeresi Kılıflı 250 mm	12	48	14,30 \$
018-RC2300	Budama Testeresi Kılıflı 300 mm	12	48	16,50 \$
018-RC2499	Budama Testeresi Kalın Diş 250mm Blisterli	12	48	12,60 \$
018-RC2500	Budama Testeresi Kalın Diş 300mm Blisterli	12	48	14,80 \$

THIN AND MEDIUM TOOTH SAW PRUNING

BUDAMA TESTERE

KOD	ÜRÜN	📦	📦	FİYAT
018-RC2501	İnce Diş Budama Testeresi 250 mm	12	72	11,00 \$
018-RC2504	Orta Diş Budama Testeresi 250 mm	12	72	11,00 \$
018-RC2704	Orta Diş Budama Testeresi 270 mm	12	72	12,00 \$

SAW BLADE

TESTERE AĞZI

KOD	ÜRÜN	📦	📦	FİYAT
018-RC2504B	Orta Diş Testere Ağzı 250 mm	20	300	7,20 \$
018-RC2704B	Orta Diş Testere Ağzı 270 mm	20	300	7,50 \$
018-RC2250B	Kalın Diş Testere Ağzı 250 mm	20	300	8,80 \$
018-RC2300B	Kalın Diş Testere Ağzı 300 mm	20	300	9,10 \$

SAW TO TRIM LATCH

BUDAMA TESTERE. MANDALLI

KOD	ÜRÜN	📦	📦	FİYAT
018-RC2502	H-160 Budama Testeresi Mandallı	12	72	11,00 \$
018-RC2503	H-210 Budama Testeresi Mandallı	12	72	13,20 \$

SCYTHE

MOTORLU TIRPAN BAŞLIĞI

Türkiye Made in

TRIMMER LINE SQUARE 450GR

TIRPAN M. 450 gr METAL

KOD	ÜRÜN	📦	📦	FİYAT
018-RC3016	M. Tirpan Başlığı	1	50	4,75 \$

KOD	ÜRÜN	📦	📦	FİYAT
018-RC3017	Misina 3.3 mm	10	30	9,00 \$

TRIMMER LINE SQUARE 450GR

TIRPAN M. 4 KÖŞE 450 gr

TRIMMER LINE HEXAGON 450GR

TIRPAN M. 6 KÖŞE 450 gr

KOD	ÜRÜN	📦	📦	FİYAT
018-RC3004	Misina 3.0 mm	6	30	6,00 \$
018-RC3006	Misina 3.3mm	6	30	6,00 \$
018-RC3008	Misina 3.5 mm	6	30	6,00 \$
018-RC3010	Misina 4.0 mm	6	30	6,00 \$

KOD	ÜRÜN	📦	📦	FİYAT
018-RC3005	Misina 3.0 mm	6	30	6,00 \$
018-RC3007	Misina 3.3mm	6	30	6,00 \$
018-RC3009	Misina 3.5 mm	6	30	6,00 \$
018-RC3011	Misina 4.0 mm	6	30	6,00 \$

GRASS CUTTING SAW

TCT ÇİM KESME TESTERESİ

KOD	ÜRÜN	📦	📦	FİYAT
018-KK3001	255x40x25,4mm Sarı / Elmas Uçlu	1	25	11,15 \$
018-KK3000	255x40x25,4mm Beyaz	1	25	10,58 \$



**PROFESYONEL
ÇÖZÜM ORTAĞINIZ**

RICO®
PROFESSIONAL

GENEL ÇEŞİTLER

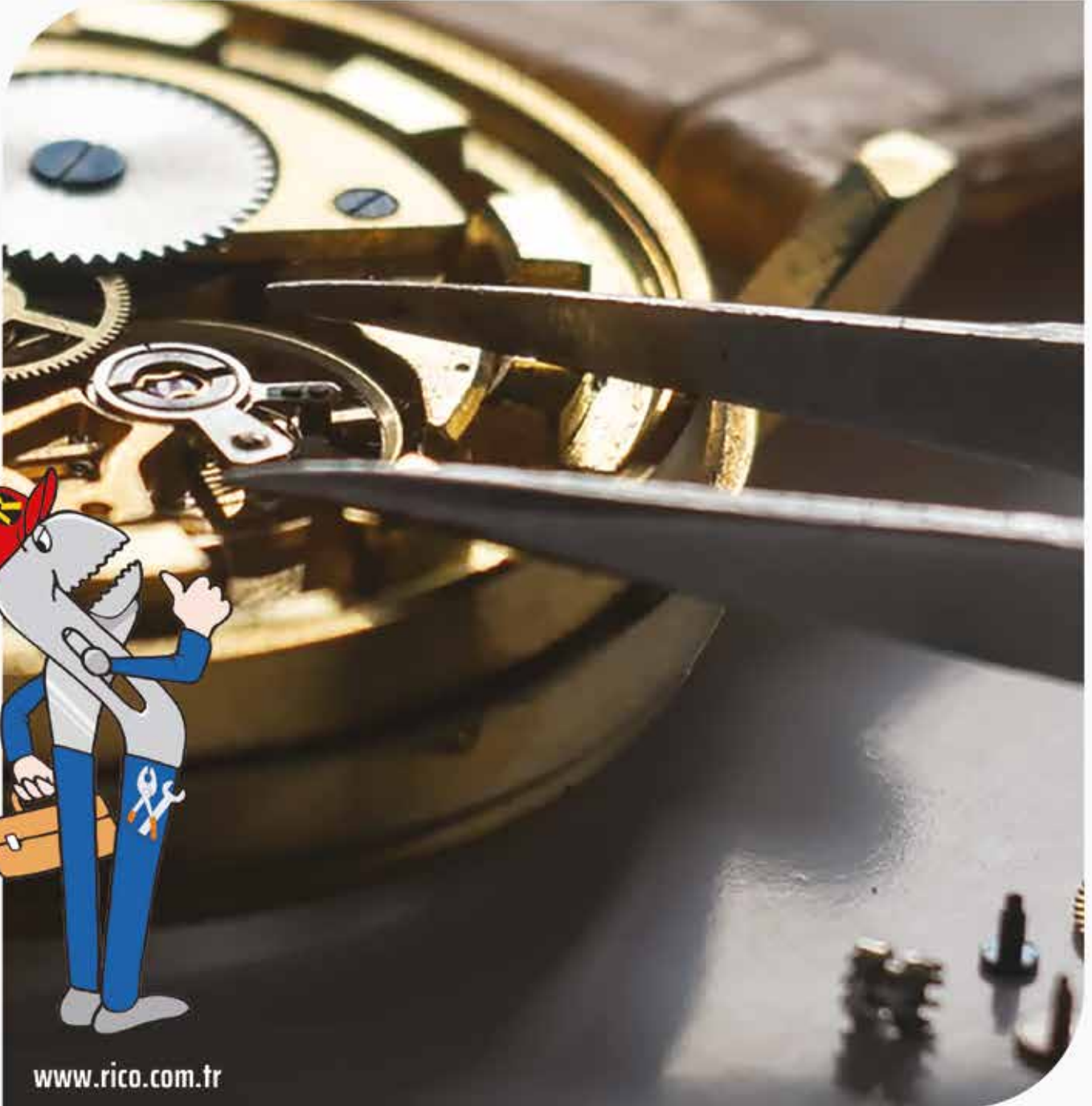

www.rico.com.tr

REVOLVIN LEATHER PUNCH

PROF. Kemer Delme

REVOLVIN LEATHER PUNCH

PROF. Çarklı Kemer Delme

KOD	ÜRÜN	📦	📦	FİYAT
025-RC1013	Prof. Kemer Delme Ayarlı Sarı-Siyah	12	48	13,00 \$

KOD	ÜRÜN	📦	📦	FİYAT
025-RC1015	Prof. Çarklı Kemer Delme	6	24	13,00 \$

HAND TACKER

METAL ZIMBA TABANÇASI

HAND TACKER

ZIMBA TABANÇASI

KOD	ÜRÜN	📦	📦	FİYAT
025-KK4378	Metal Zimba Tabancası - Orange	10	40	11,00 \$

KOD	ÜRÜN	📦	📦	FİYAT
025-KK4377	4-IN1 Zimba Tabancası	6	24	24,00 \$

FINE WIRE STAPLES

ZIMBA TELİ

KOD	ÜRÜN	📦	📦	FİYAT
025-KK4306	Zimba Teli 1,2 x 6 mm 206 İnce	10	50	1,85 \$
025-KK4308	Zimba Teli 1,2x8 mm 208 İnce	10	50	1,90 \$
025-KK4386	Zimba Teli 8 mm Kalın	10	40	3,30 \$
025-KK4406	Zimba Teli U Tipi (Kablo İçin)	10	40	3,30 \$

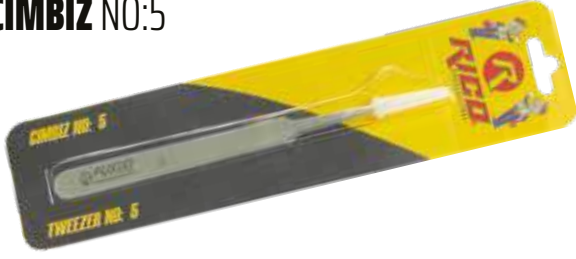

TWEEZER

CIMBIZ NO:5

KOD	ÜRÜN	📦	📦	FİYAT
025-RC7789	Cimbiz No:5	12	120	1,80 \$

TWEEZER

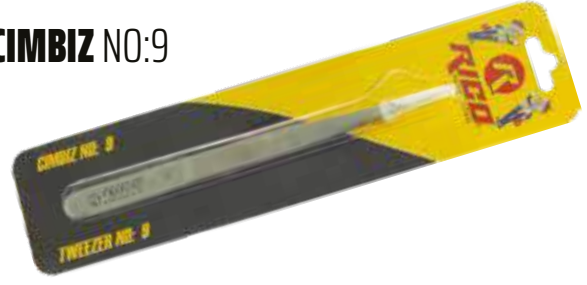
CIMBIZ NO:9

KOD	ÜRÜN	📦	📦	FİYAT
025-RC7790	Cimbiz No:9	12	120	1,80 \$

MM TWEEZERS W/BLISTER

CIMBIZ MM BİLİSTERLİ

KOD	ÜRÜN	📦	📦	FİYAT
025-RC7791	Cimbiz mm Bilisterli	12	120	2,20 \$

GG TWEEZERS W/BLISTER

CIMBIZ GG BİLİSTERLİ

KOD	ÜRÜN	📦	📦	FİYAT
025-RC7792	Cimbiz GG Bilisterli	12	120	2,20 \$

EPOXY COATED TWEEZERS 5A

CIMBIZ EPOKSİ KAPLAMALI

KOD	ÜRÜN	📦	📦	FİYAT
025-RC7793	Cimbiz Epoksi Kaplamalı 5A	12	120	2,20 \$

EPOXY COATED TWEEZERS 7A

CIMBIZ EPOKSİ KAPLAMALI

KOD	ÜRÜN	📦	📦	FİYAT
025-RC7794	Cimbiz Epoksi Kaplamalı 7A	12	120	2,20 \$

EPOXY COATED TWEEZERS AA

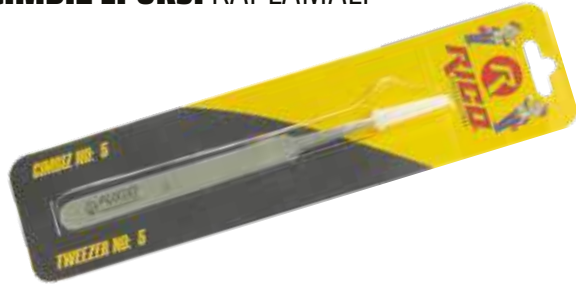
CIMBIZ EPOKSİ KAPLAMALI

KOD	ÜRÜN	📦	📦	FİYAT
025-RC7795	Cimbiz Epoksi Kaplamalı AA	12	120	2,20 \$

EPOXY COATED TWEEZERS GG

CIMBIZ EPOKSİ KAPLAMALI

KOD	ÜRÜN	📦	📦	FİYAT
025-RC7796	Cimbiz Epoksi Kaplamalı GG	12	120	2,20 \$

EPOXY COATED TWEEZERS 00

CIMBIZ EPOKSİ KAPLAMALI



DIAMOND LONG NOSE TWEEZERS

CIMBIZ ELMAS UÇLU UZUN



KOD	ÜRÜN	📦	📦	FİYAT
025-RC7797	Cımbız Epoksi Kaplamalı 00	12	120	2,20 \$

KOD	ÜRÜN	📦	📦	FİYAT
025-RC7798	Cımbız Elmas Uçlu Uzun	12	120	2,53 \$

EPOXY COATED DIAMOND NOSE
ELMAS UÇLU EPOKSİ KAPLAMALI



DIAMOND TWEEZER GERMAN TYPE
MEDIUM POINT 133M

CIMBIZ ELMAS ALMAN TİPİ



KOD	ÜRÜN	📦	📦	FİYAT
025-RC7799	Elmas Uçlu Epoksi Kaplamalı	12	120	2,53 \$

KOD	ÜRÜN	📦	📦	FİYAT
025-RC7801	Cımbız Elmas Alman Tip Orta Uç	12	120	2,53 \$

TWEEZER WITH GUIDE PIN 156 MM
CURVED 214

KLAVUZ PİMLİ EĞRİ ORTA



TWEEZER WITH GUIDE PIN 156 MM
CURVED 215

KLAVUZ UÇLU EĞRİ KALIN



KOD	ÜRÜN	📦	📦	FİYAT
025-RC7806	Cımbız Klavuz Pimli Eğri Orta	12	120	3,00 \$

KOD	ÜRÜN	📦	📦	FİYAT
025-RC7807	Cımbız Klavuz Uçlu Eğri Kalın	12	120	3,00 \$

TWEEZER

CIMBIZ NO: 1



KOD	ÜRÜN	📦	📦	FİYAT
025-RC7753	Cımbız No: 1	12	120	1,65 \$



TWEEZER 442A

CIMBIZ 442A

KOD	ÜRÜN			FİYAT
025-RC7814	Cimbiz 442A	12	120	4,55 \$

TWEEZER

EPOKSİ KAPLAMALI NO: 3C

KOD	ÜRÜN			FİYAT
025-RC7758	Epoksi Kaplamalı 3c	12	120	1,70 \$

TWEEZER

EPOKSİ KAPLAMALI NO: 7A

KOD	ÜRÜN			FİYAT
025-RC7761	Epoksi Kaplamalı Cimbiz 7A	12	120	1,70 \$

DIAMOND TWEEZER

ALMAN TİP CIMBIZ DÜZ

KOD	ÜRÜN			FİYAT
025-RC7767	Alman Tip Düz Cimbiz	12	120	2,10 \$

DIAMOND TWEEZER

ALMAN TİP CIMBIZ ORTA

KOD	ÜRÜN			FİYAT
025-RC7768	Alman Tip Orta Cimbiz	12	120	1,70 \$

DIAMOND TWEEZER SIDE LOCK

ELMAS UÇLU SÜRGÜLÜ

KOD	ÜRÜN			FİYAT
025-RC7770	Elmas Uçlu Sürgülü Düz Cimbiz	12	120	1,70 \$

SOLDERING TWEEZER FIBER GRIP

FİBER LEHİM DÜZ

KOD	ÜRÜN			FİYAT
025-RC7772	Fiber Lehim Düz Cimbiz	12	120	1,55 \$

SOLDERING TWEEZER 90°

FİBER LEHİM 90° EĞİK

KOD	ÜRÜN			FİYAT
025-RC7773	Fiber Lehim Cimbiz 90° Eğik	12	120	1,55 \$

DENTAL TWEEZER WITH PIN

KLAVUZ PİMLİ DÜZ



DENTAL TWEEZER WITH PIN CURVED

KLAVUZ PİMLİ DÜZ



KOD	ÜRÜN	📦	📦	FİYAT
025-RC7777	Cımbız Klavuz Pimli Düz	12	120	2,10 \$

KOD	ÜRÜN	📦	📦	FİYAT
025-RC7778	Klavuz Pimli Eğri İnce Düz	12	120	2,10 \$

TWEEZER WITH PIN CURVED

KLAVUZ PİMLİ EĞRİ ORTA



TWEEZER DOUBLE BENT

ÇİFT EĞİK UÇ



KOD	ÜRÜN	📦	📦	FİYAT
025-RC7779	Klavuz Pimli Eğri Orta	12	120	2,47 \$

KOD	ÜRÜN	📦	📦	FİYAT
025-RC7781	Cımbız Çift Eğik Uç	12	120	2,47 \$

5PCS TWEEZER STAINLESS SHORT

5 PARÇA PASLANMAZ KISA



5PCS TWEEZER STAINLESS

5 PARÇA PASLANMAZ



KOD	ÜRÜN	📦	📦	FİYAT
025-RC7782	5PC Paslanmaz Cımbız Set Kısa	10	100	6,00 \$

KOD	ÜRÜN	📦	📦	FİYAT
025-RC7783	5PC Paslanmaz Cımbız Seti	10	100	9,35 \$

6PCS DIAMOND KIT SET

6 PARÇA ELMAS SET



12PCS TWEEZER SET

12 PARÇA CIMBIZ SET



KOD	ÜRÜN	📦	📦	FİYAT
025-RC7785	6PC Elmas Cımbız Set	10	100	13,20 \$

KOD	ÜRÜN	📦	📦	FİYAT
025-RC7787	12PC Cımbız Set	10	100	19,80 \$

DIAMOND CONTINUOUS SAW

ELMAS DAİRE TESTERE



KOD	ÜRÜN	☐	📦	FİYAT
018-KK2110	Elmas 115x2.0x22 Sürekli	1	200	4,35 \$
018-KK2111	Elmas 180x2.2x22 Sürekli	1	50	11,00 \$
018-KK2112	Elmas 230x2.4x22 Sürekli	1	25	16,35 \$

PROF. WOOD CIRCLE SAW

PROF. DAİRE TESTERE



KOD	ÜRÜN	☐	📦	FİYAT
018-KK1320	Daire Testere 180x22	10	100	5,00 \$

CUTTING AND GRINDING WHEELS FOR METALS & STONE

FLEX TAŞ



KOD	ÜRÜN	☐	📦	FİYAT
024-KK0230	Flex Taş 230x3x22 Mermer	25	50	2,75 \$

DIAMOND TURBO SAW

ELMAS DAİRE TESTERE



KOD	ÜRÜN	☐	📦	FİYAT
018-KK2113	Elmas 115x2.0x22 Turbo	1	200	5,00 \$
018-KK2114	Elmas 180x2.2x22 Turbo	1	50	12,00 \$
018-KK2115	Elmas 230x2.4x22 Turbo	1	25	17,45 \$

TAŞLAMA SOMUNU

KONİK DİSK ALTI



TAŞLAMA SOMUN TAKIMI



KOD	ÜRÜN	☐	📦	FİYAT
024-KK8824	Konik Disk Altı	1	30	1,20 \$
024-KK8823	Taşlama Somun Takımı	1	30	2,40 \$

GLASS CUTTER

CAM Kesme Elması

ALUMINUM CUTTING KNIFE 9 mm

ALÜMİNYUM MAKET BİÇAĞI 9 mm

KOD	ÜRÜN	📦	📦	FİYAT
025-KK4385	Cam Kesme Elması (Düzine)	12	480	28,35 \$
025-BB4385	Cam Kesme Elması (Adet)	1	480	2,37 \$

KOD	ÜRÜN	📦	📦	FİYAT
019-KK7235	Alüminyum Maket Bıçağı 9 mm	50	50	1,10 \$

FLATCHISEL VV/HAMMER HANDLE

DARBELİ İSKARPELALAR

SCRAPERS W/WOODEN HANDLE NEW TYPE

AĞAÇ SAPLI İSPATULA YENİ TİP

KOD	ÜRÜN	📦	📦	FİYAT
017-KK1975	Darbeli Iskarpela 6 mm	6	60	6,50 \$
017-KK1976	Darbeli Iskarpela 8 mm	6	60	6,80 \$

KOD	ÜRÜN	📦	📦	FİYAT
017-RA0300	Ağaç Saplı İspatula Yeni Tip 3 cm	12	240	1,20 \$
017-RA0400	Ağaç Saplı İspatula Yeni Tip 4 cm	12	240	1,30 \$
017-RA0500	Ağaç Saplı İspatula Yeni Tip 5 cm	12	240	1,40 \$
017-RA0600	Ağaç Saplı İspatula Yeni Tip 6 cm	12	240	1,50 \$
017-RA0700	Ağaç Saplı İspatula Yeni Tip 7 cm	12	240	1,60 \$
017-RA0800	Ağaç Saplı İspatula Yeni Tip 8 cm	12	240	1,65 \$
017-RA0900	Ağaç Saplı İspatula Yeni Tip 9 cm	12	240	1,85 \$
017-RA1000	Ağaç Saplı İspatula Yeni Tip 10 cm	12	240	1,95 \$
017-RA1200	Ağaç Saplı İspatula Yeni Tip 12 cm	12	240	2,05 \$

DİJİTAL MULTİMETRE

DT-830D



KOD	ÜRÜN	📦	📦	FİYAT
011-RC0360	Dijital Multimetre	1	1	5,00 \$

DİJİTAL MULTİMETRE

DT-33D



KOD	ÜRÜN	📦	📦	FİYAT
011-RC0033	Dijital Multimetre	1	1	13,60 \$

DİJİTAL MULTİMETRE

DT-890DL



KOD	ÜRÜN	📦	📦	FİYAT
011-RC0890	Dijital Multimetre	1	1	22,00 \$

DİJİTAL MULTİMETRE

MY-62



KOD	ÜRÜN	📦	📦	FİYAT
011-RC0062	Dijital Multimetre	1	1	17,77 \$

PENSA AMPERMETRE

DT-266



KOD	ÜRÜN	📦	📦	FİYAT
011-RC0266	Pensa Ampermetre	1	1	10,69 \$

MONO BLOCK VERNIER CALİPER**DİJİTAL**
KUMPAS

KOD	ÜRÜN	📦	📦	FİYAT
010-RC0002	Dijital Kumpas	1	50	21,00 \$

“Kalite İnsana Saygıdır”

TAHTAKALE ŞUBESİ



RIGCO
PROFESSIONAL



info@ricokarakus.com



RICO[®]
PROFESSIONAL

MERKEZ

İstoç Toptancılar Çarşısı 16. Ada No: 20/22
Mahmutbey / İstanbul

+90 212 659 07 09

+90 212 659 07 08

ŞUBE

Deveoğlu Yokuşu Şeyh Davut Sk. Şeyh Davut Hanı No:1/1
Eminönü / İstanbul

+90 212 528 46 53

+90 212 511 64 80

ricokarakus.com

info@ricokarakus.com

/ricotools